

Схема скважин
К5305.0000.0000

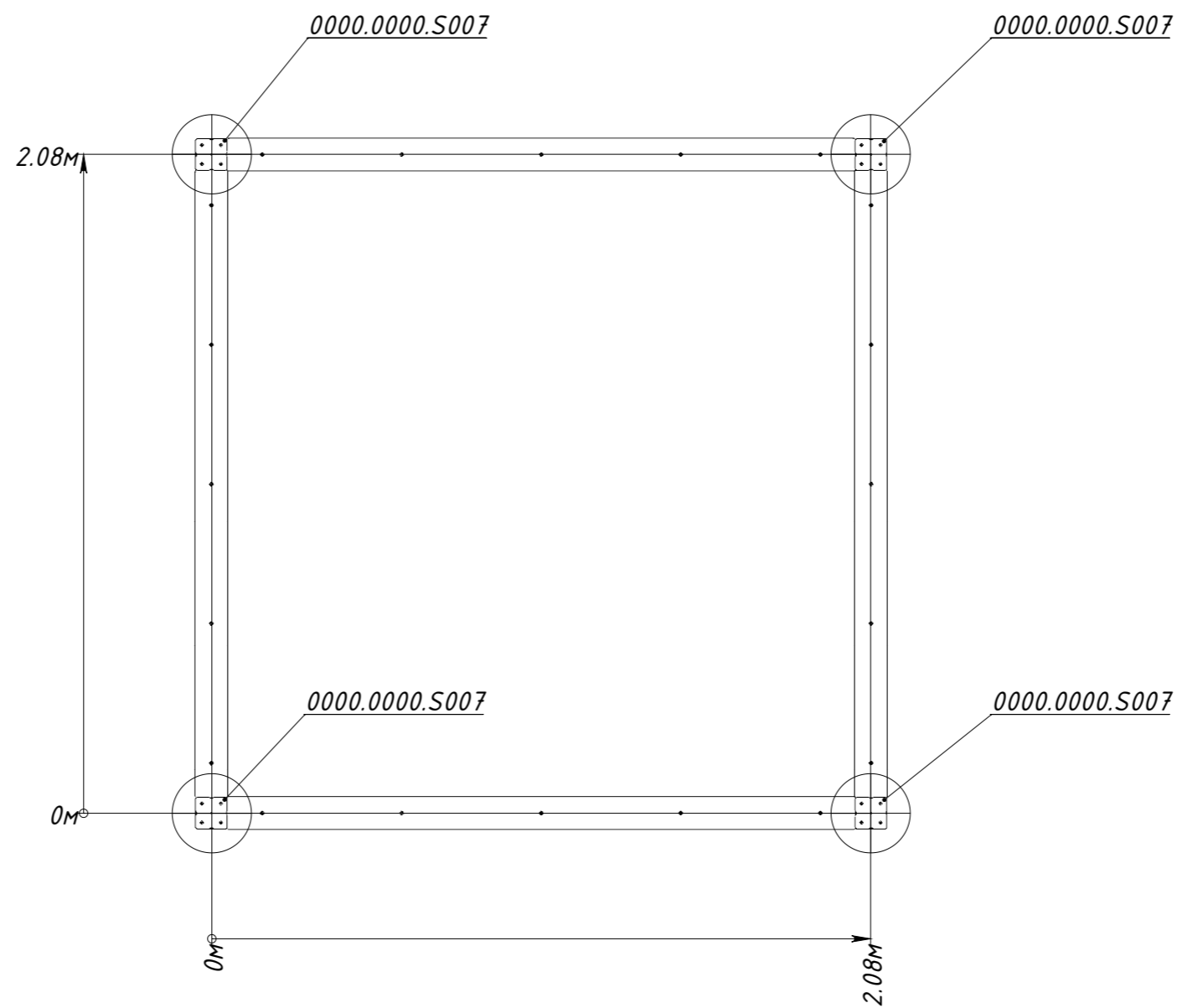

Рисунок 1