

Схема скважин  
E6103.0000.0000

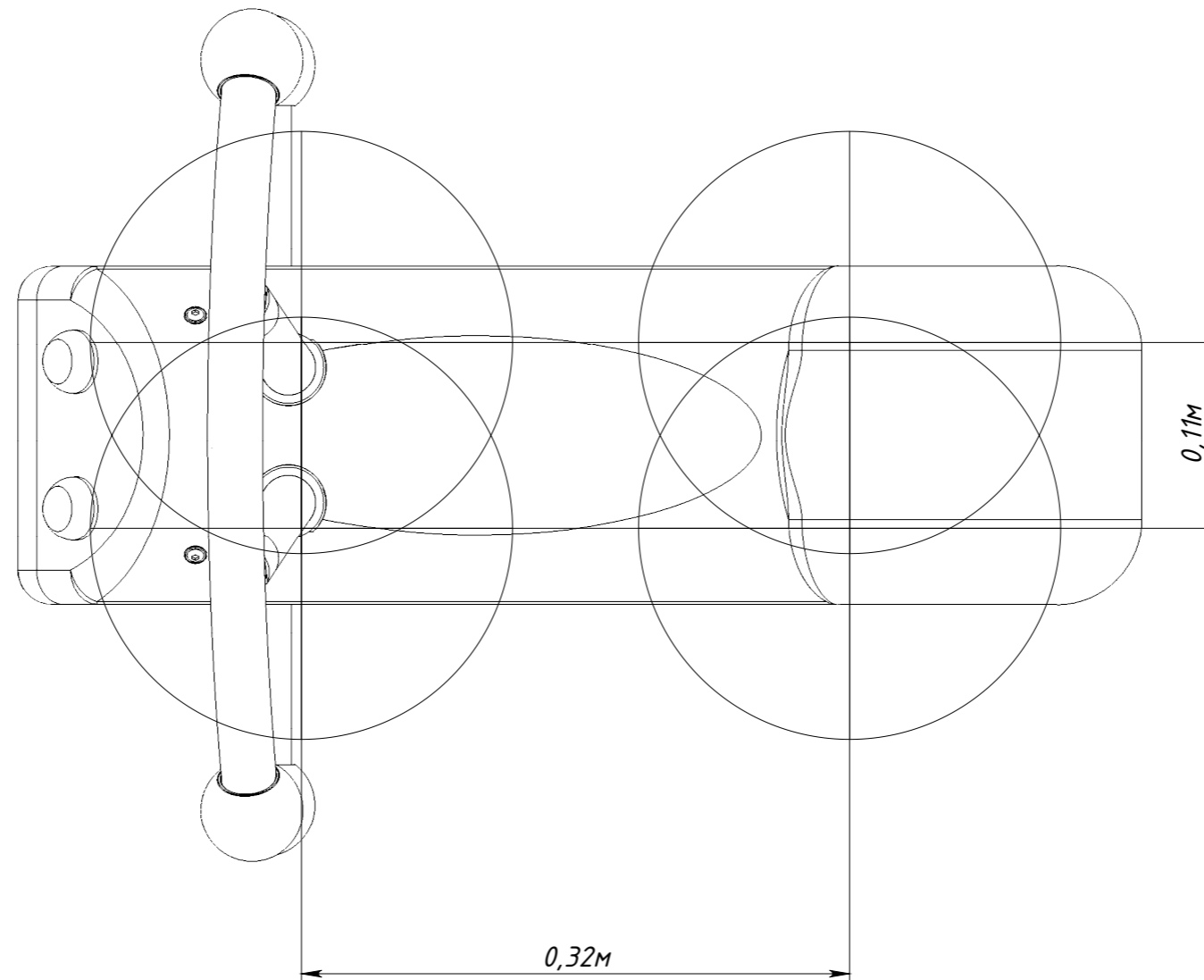

Рисунок 1