

Схема скважин
E5005.0000.0000

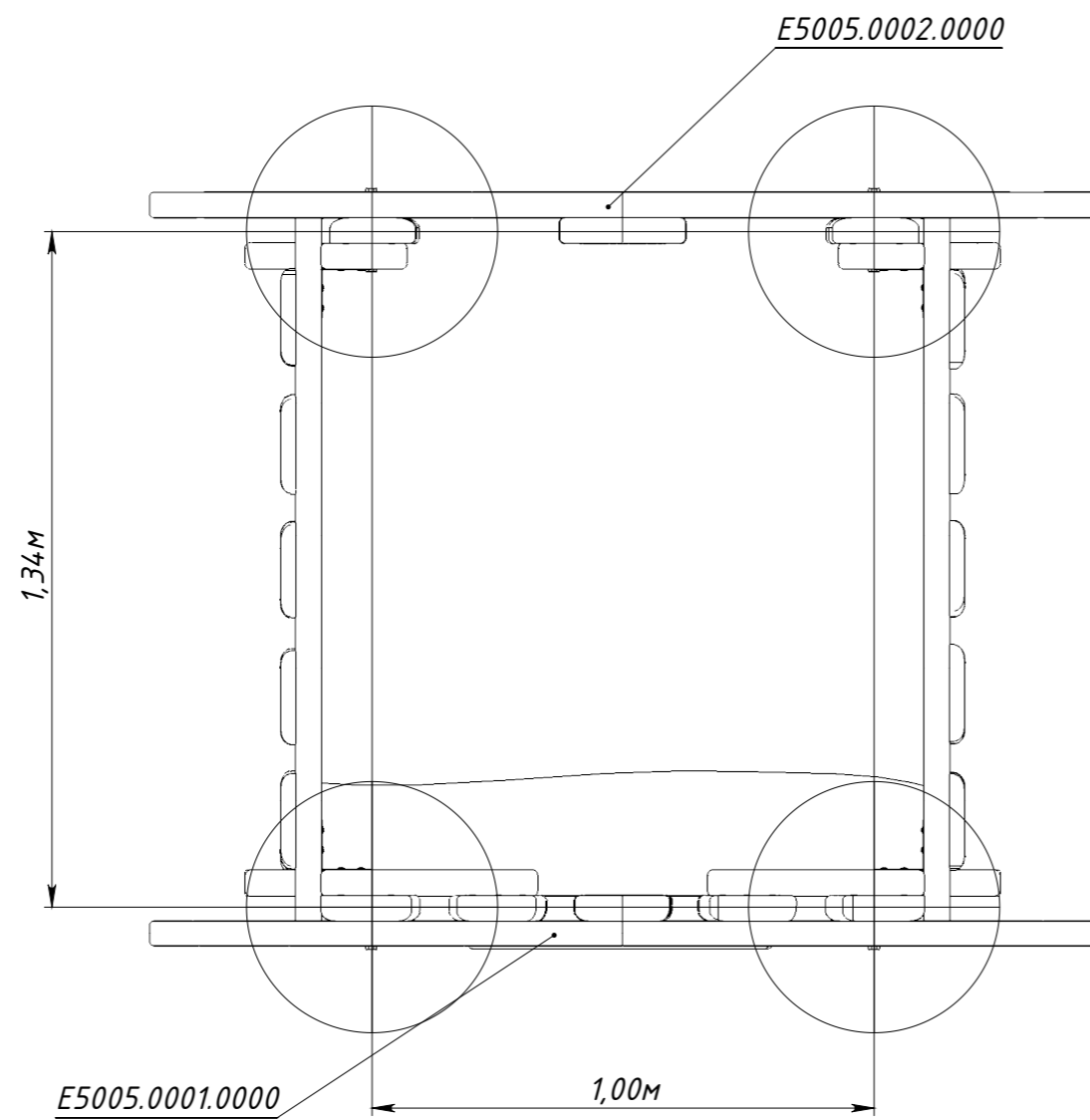

Рисунок 1