

Схема скважин  
7833.0000.0000

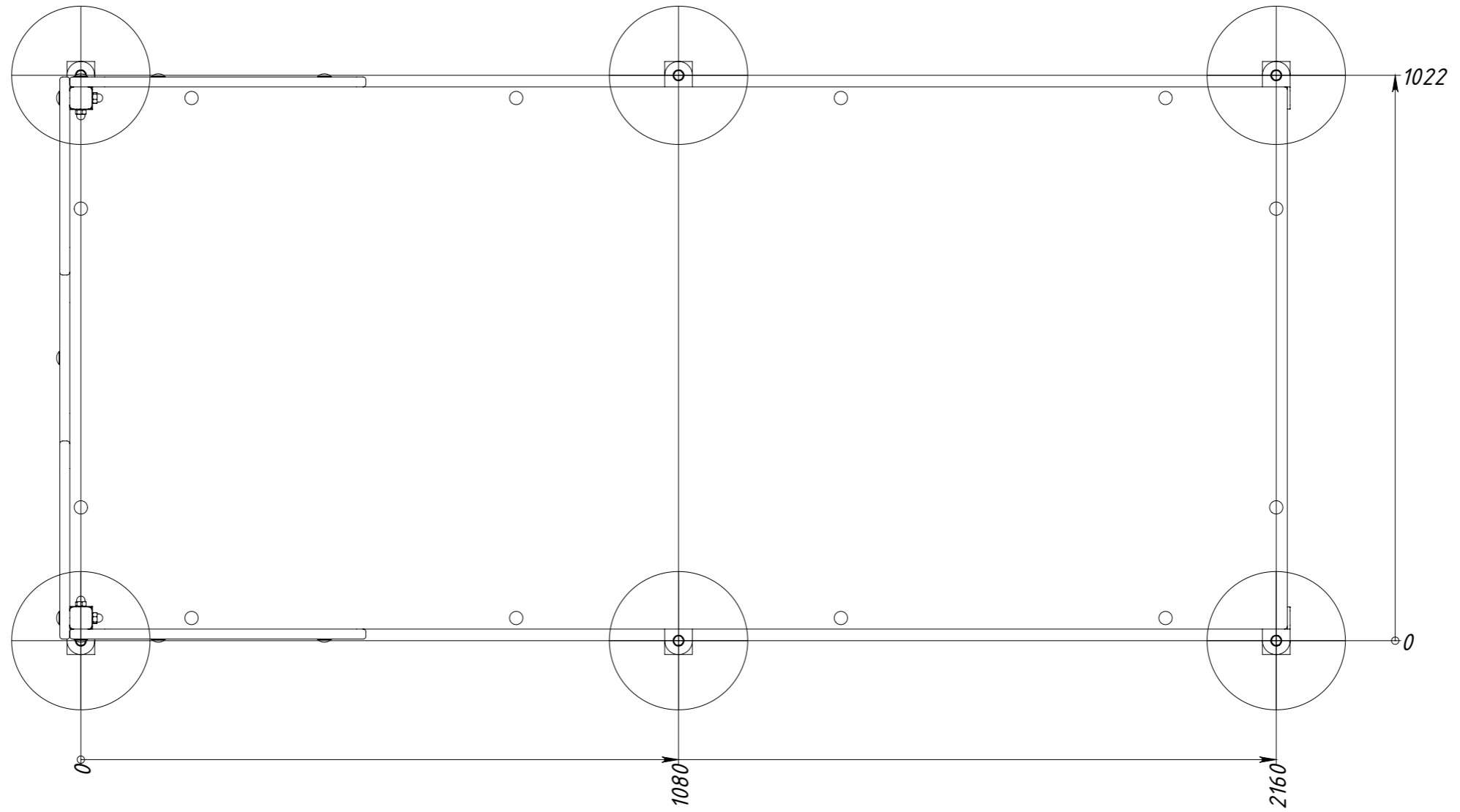

Рисунок 1