

Схема скважин
7825.0000.0000

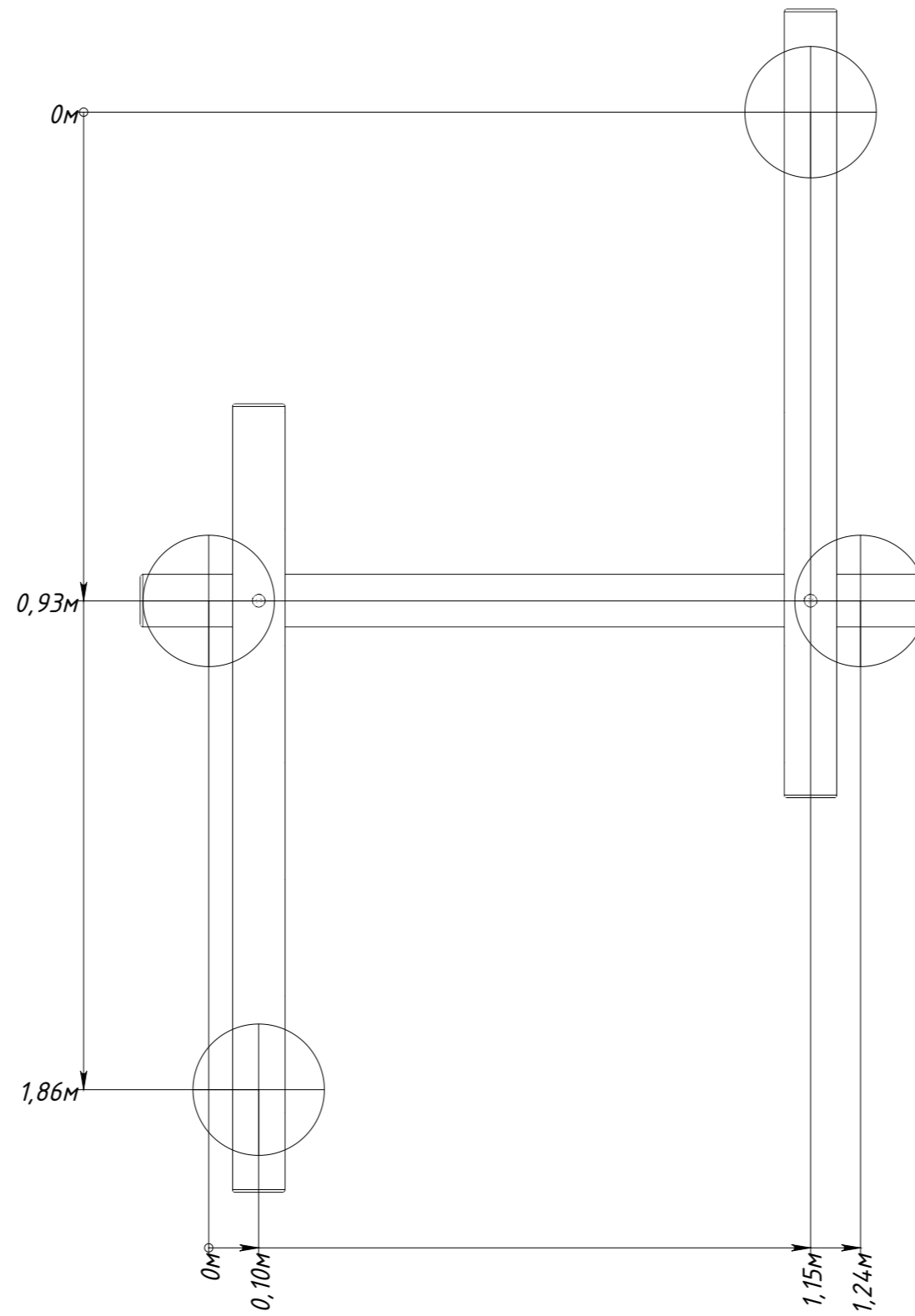

Рисунок 1