

Схема скважин
6328.0000.0000

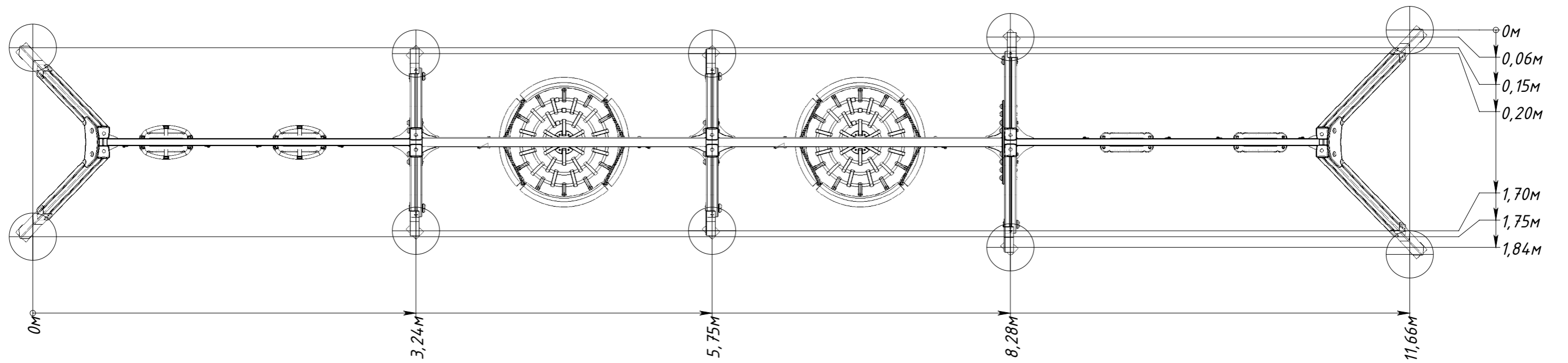

Рисунок 1