

Схема скважин
6327.0000.0000

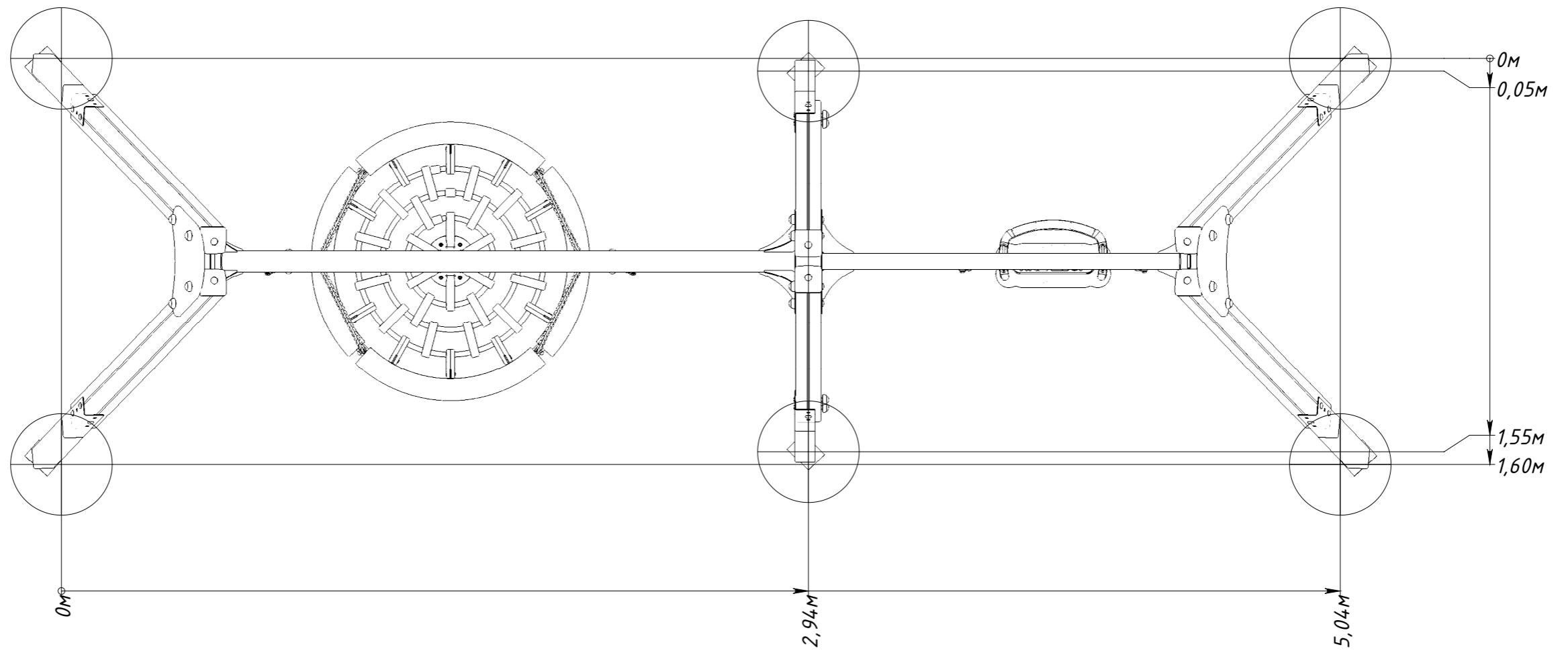

Рисунок 1