

Схема скважин
6218.0000.0000

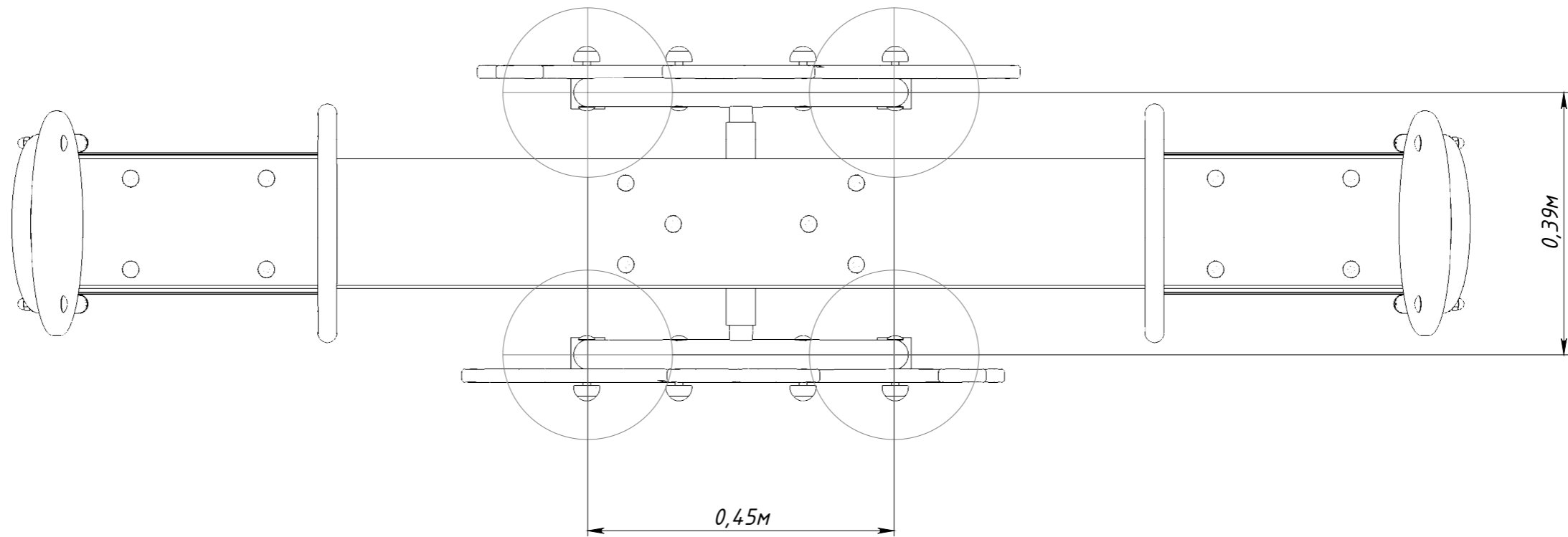

Рисунок 1