

Схема скважин
6216.0000.0000

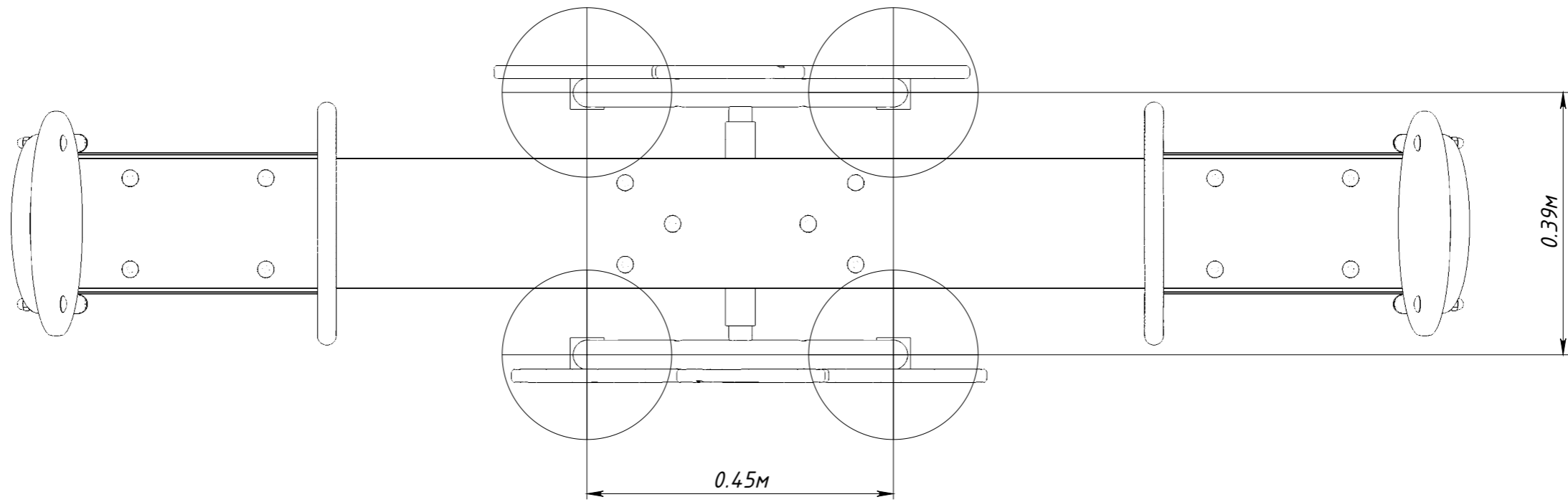

Рисунок 1