

Схема скважин
6206.0000.0000

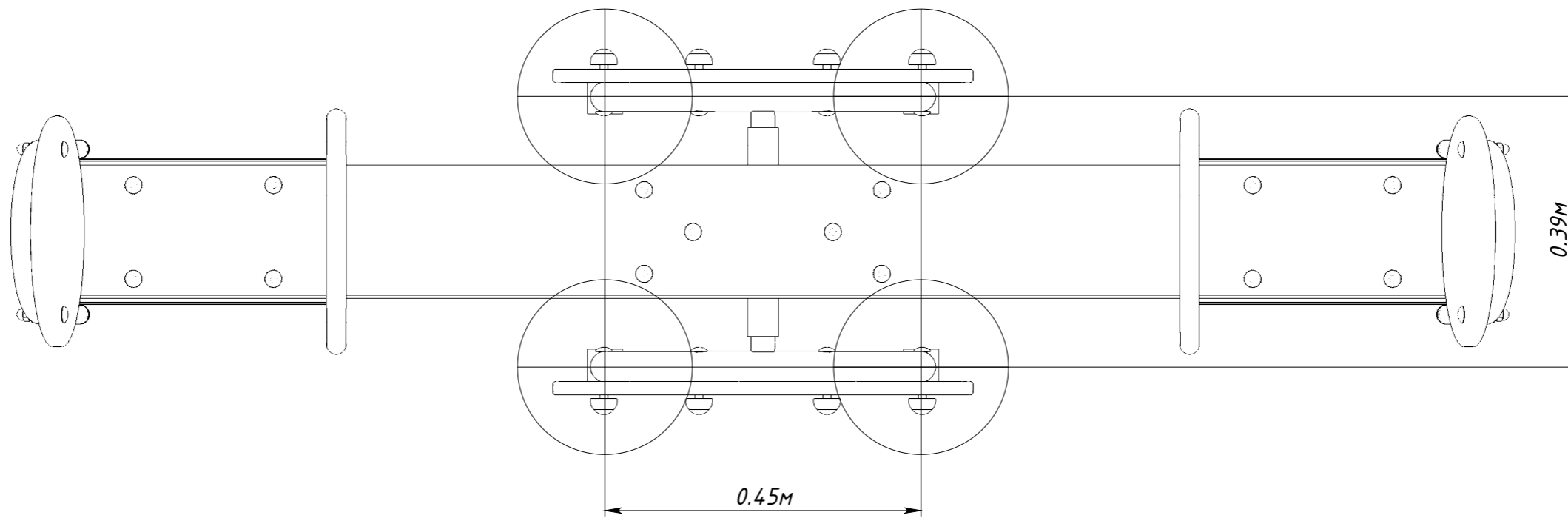

Рисунок 1