

**Схема скважин
6203.0000.0000**

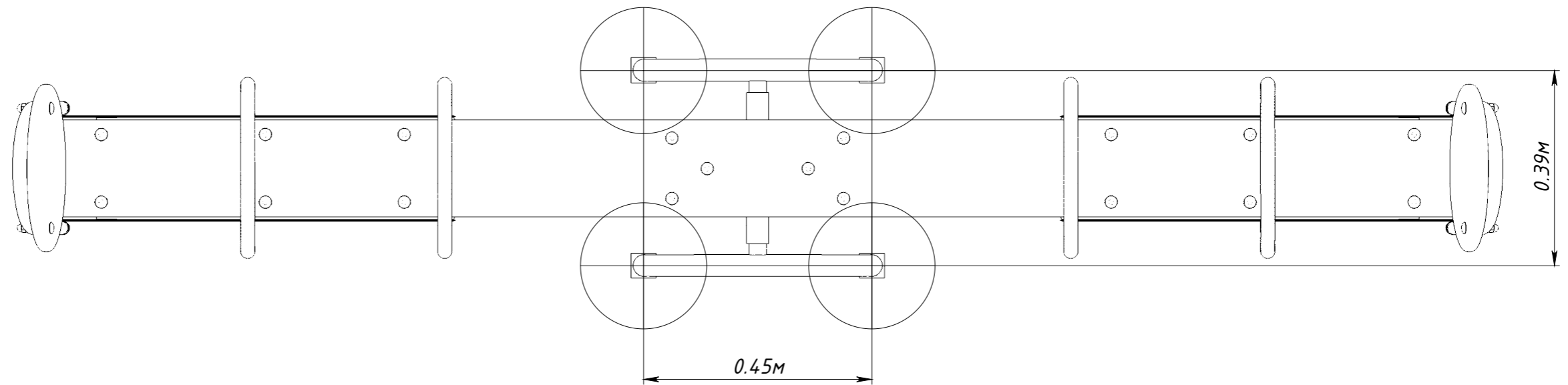

Рисунок 1