

Схема скважин  
6140.0000.0000

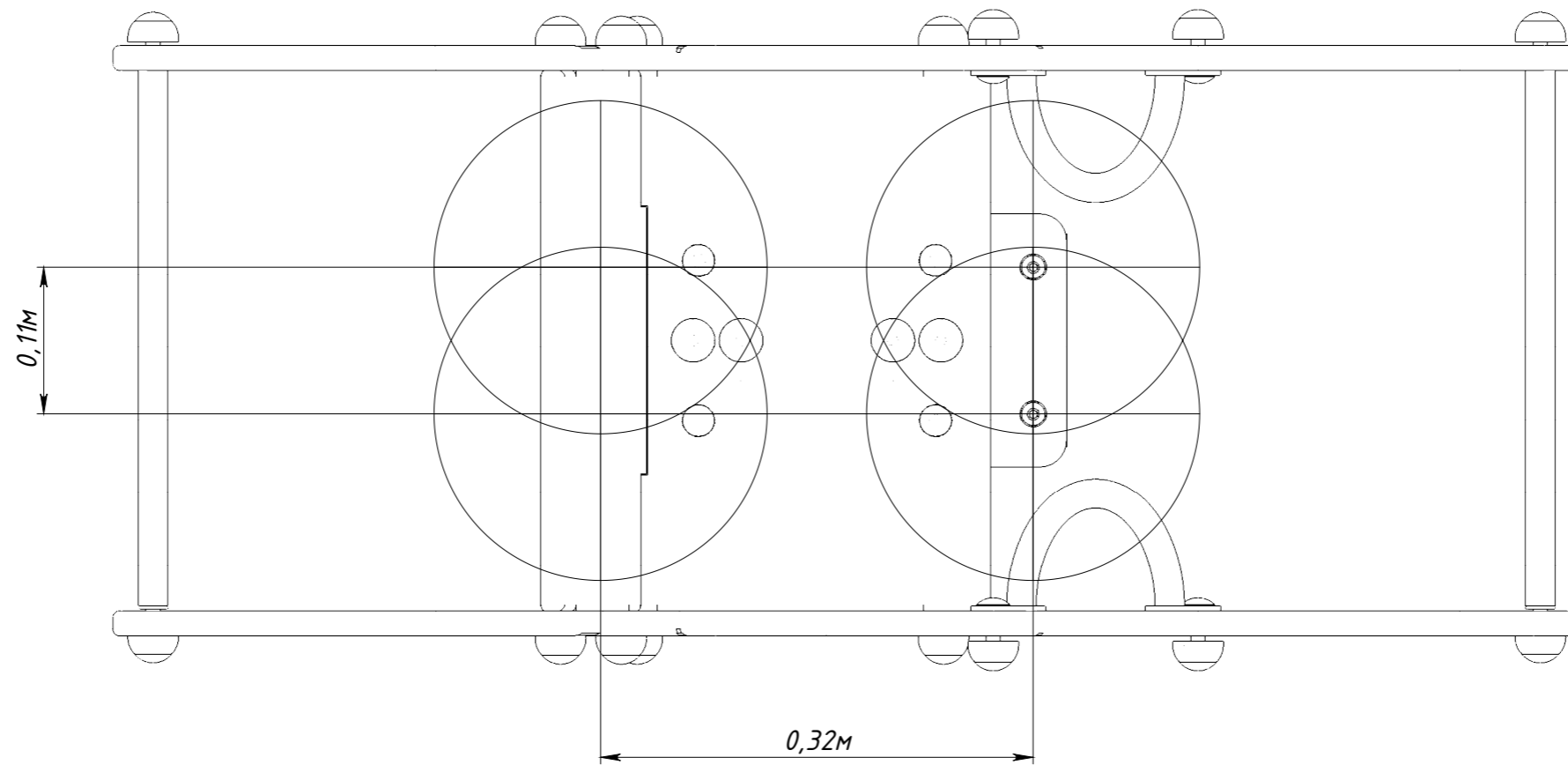

Рисунок 1