

Схема скважин
6138.0000.0000

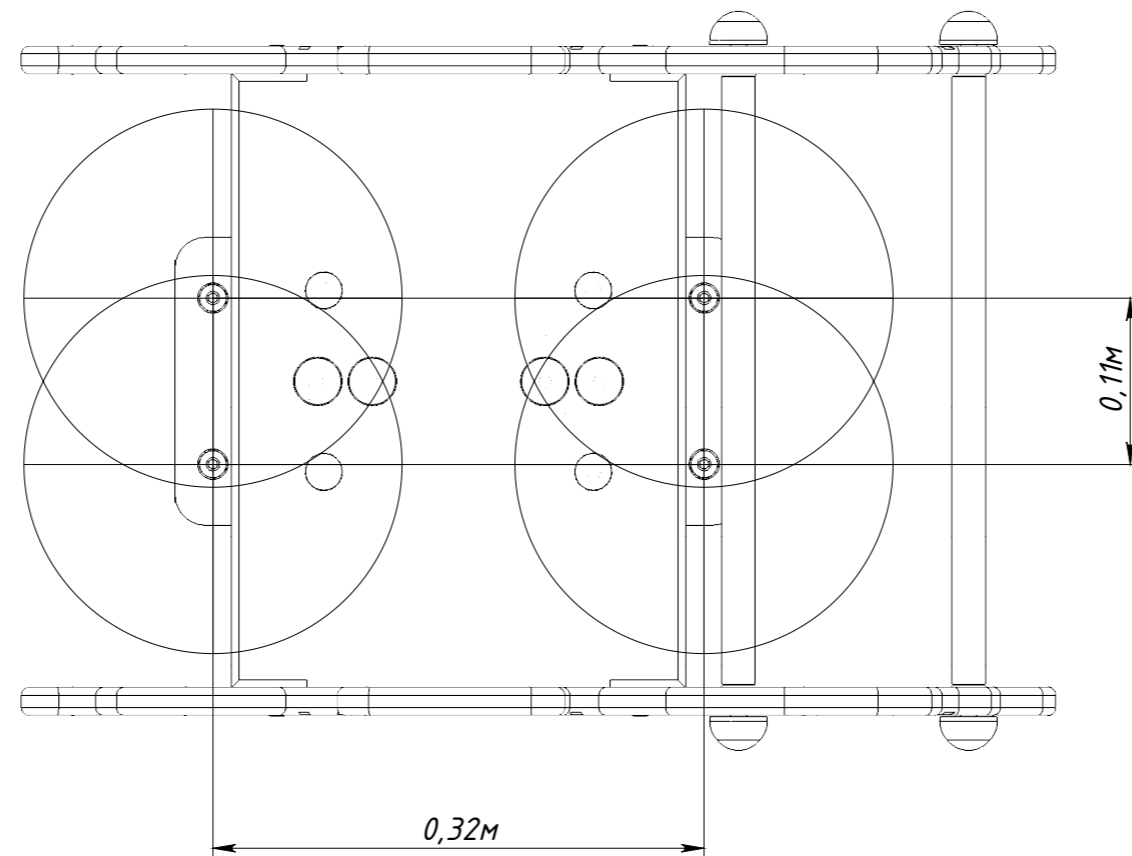

Рисунок 1