

Схема скважин
6130.0000.0000

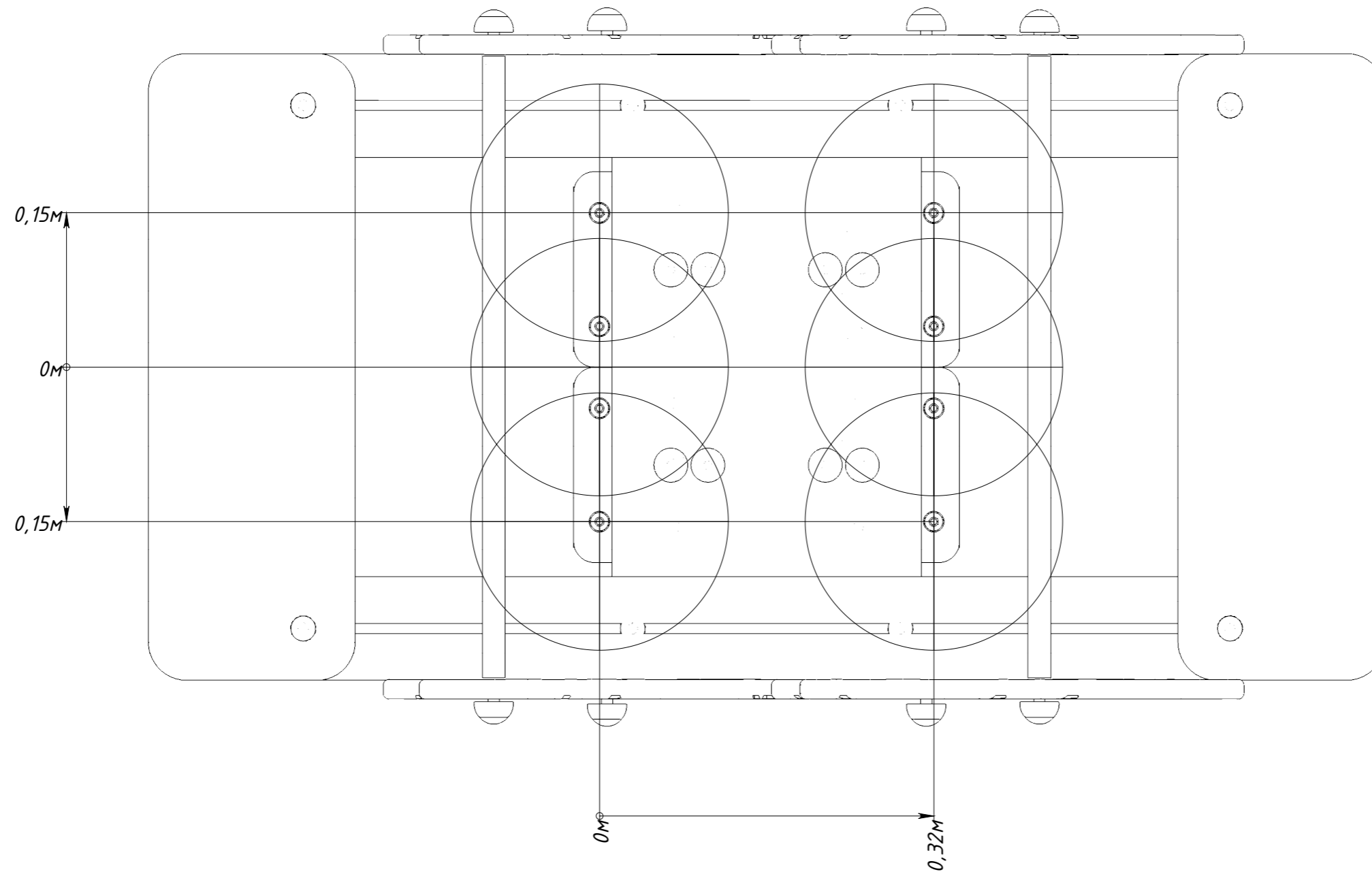

Рисунок 1