

Схема скважин
6110.0000.0000

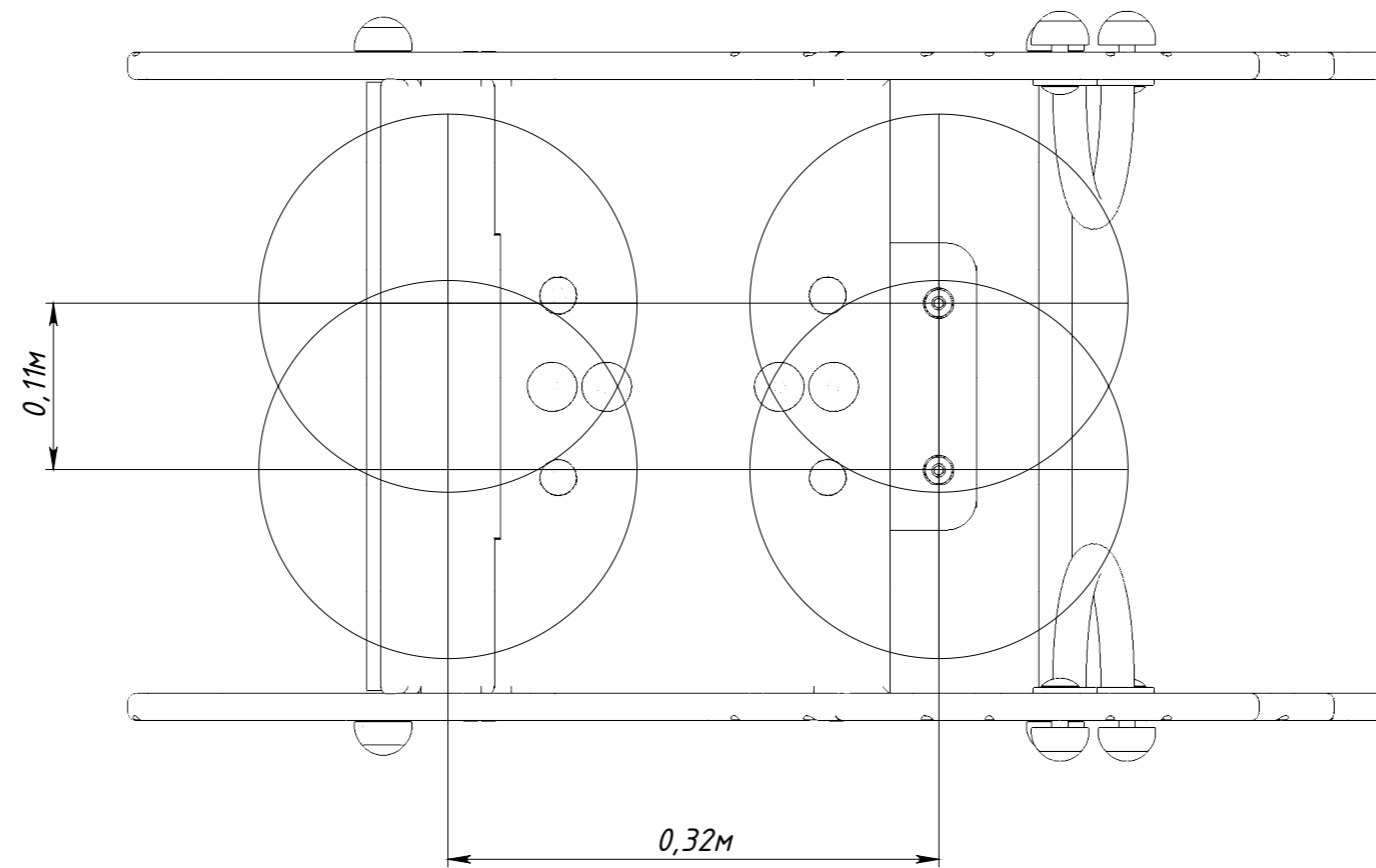

Рисунок 1