

Схема скважин
6104.0000.0000

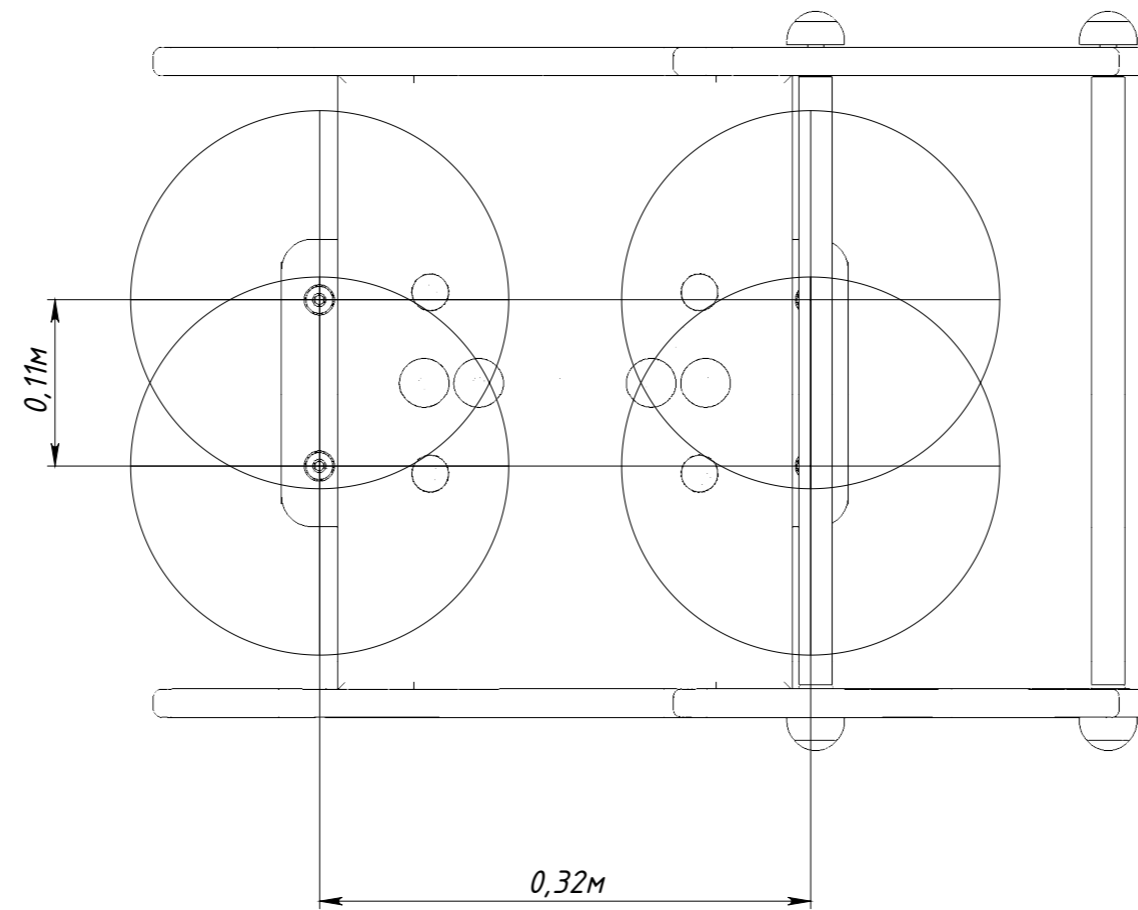

Рисунок 1