

Схема скважин  
5311.0000.0000

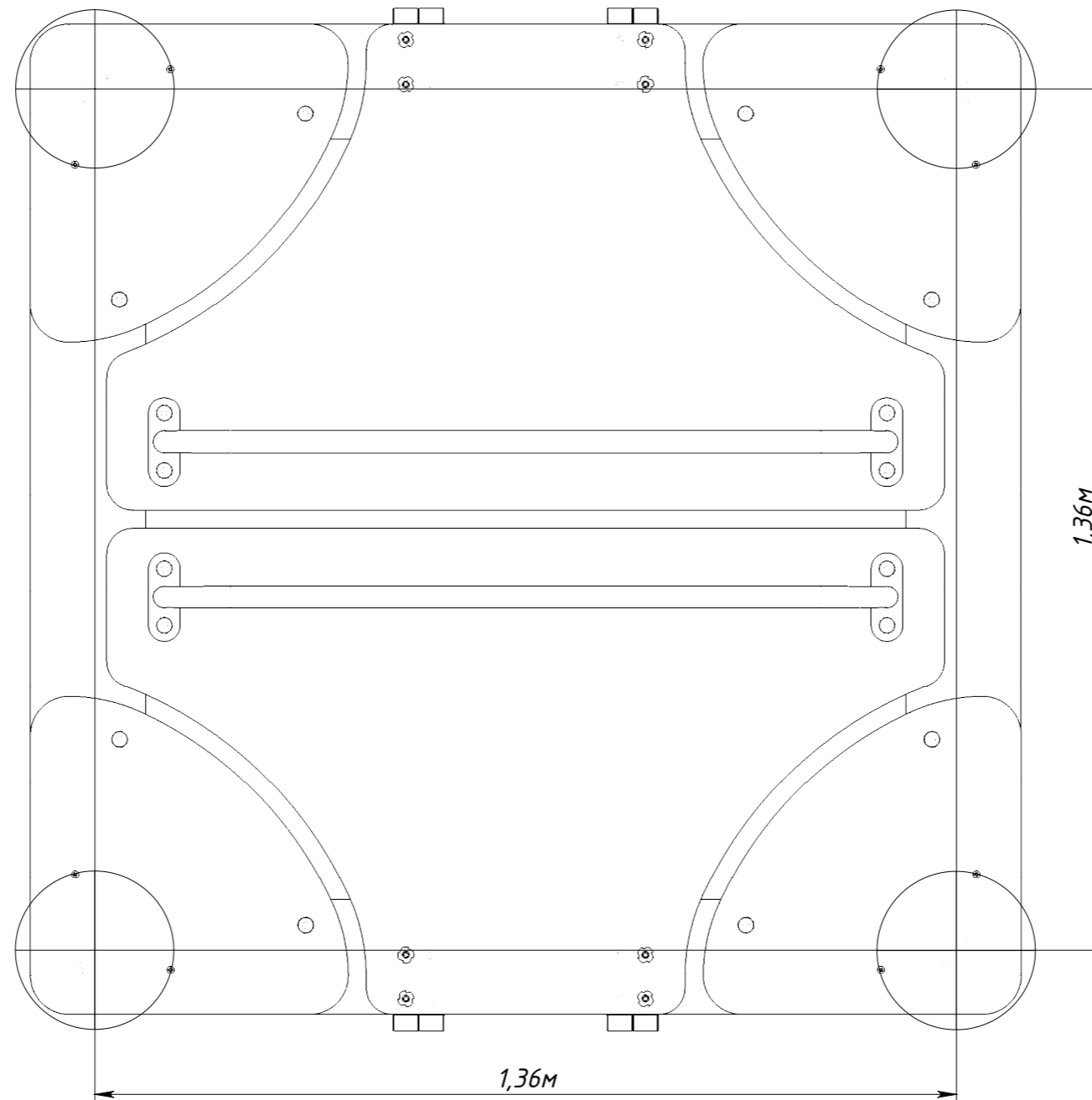

Рисунок 1