

Схема скважин
5303.0000.0000

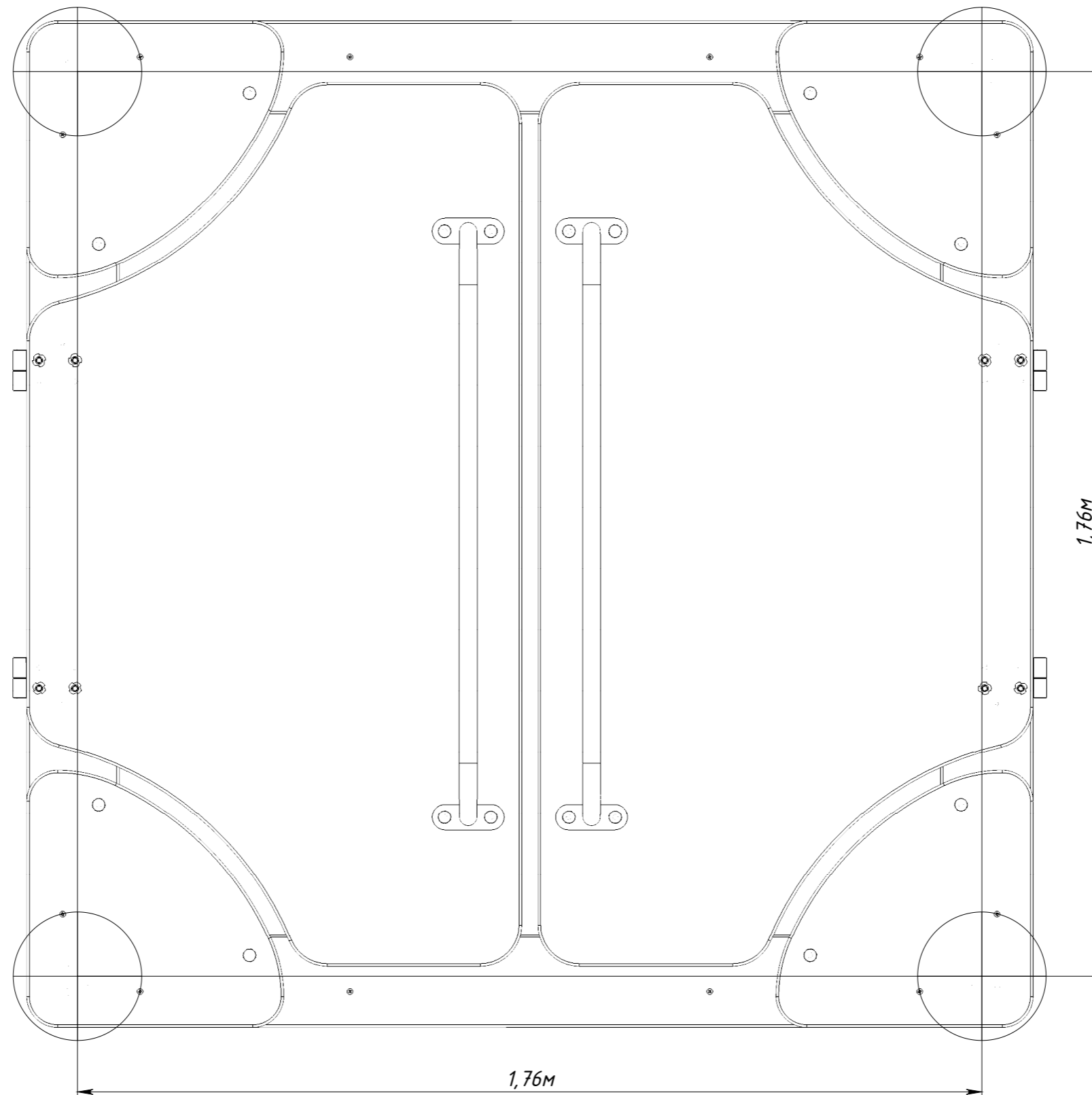

Рисунок 1