

**Схема скважин
4027.0000.0000**

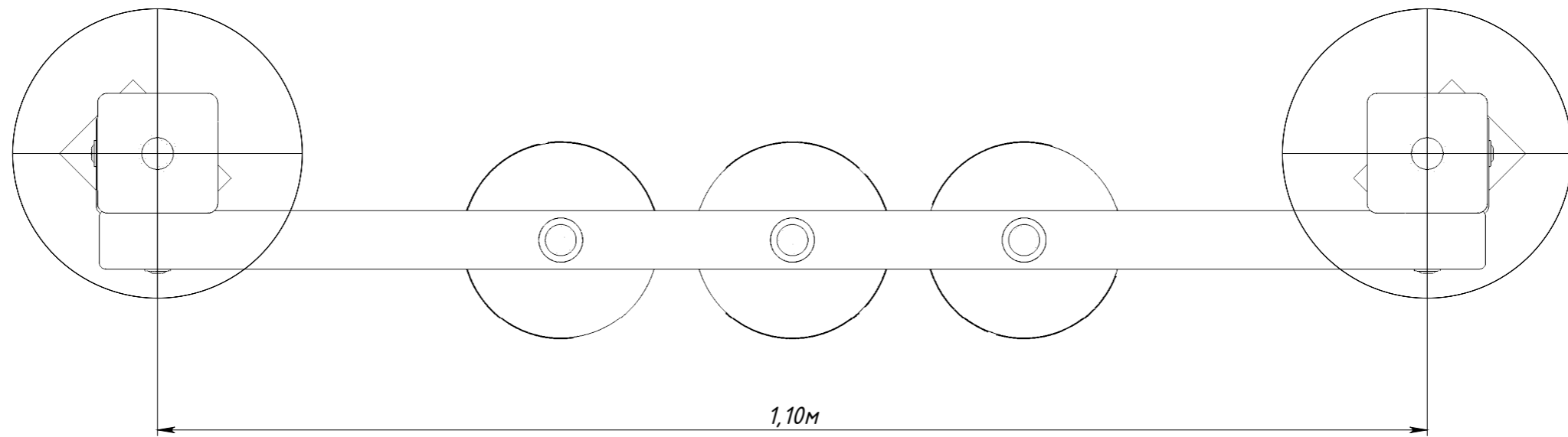

Рисунок 1