

Схема скважин
4009.0000.0000

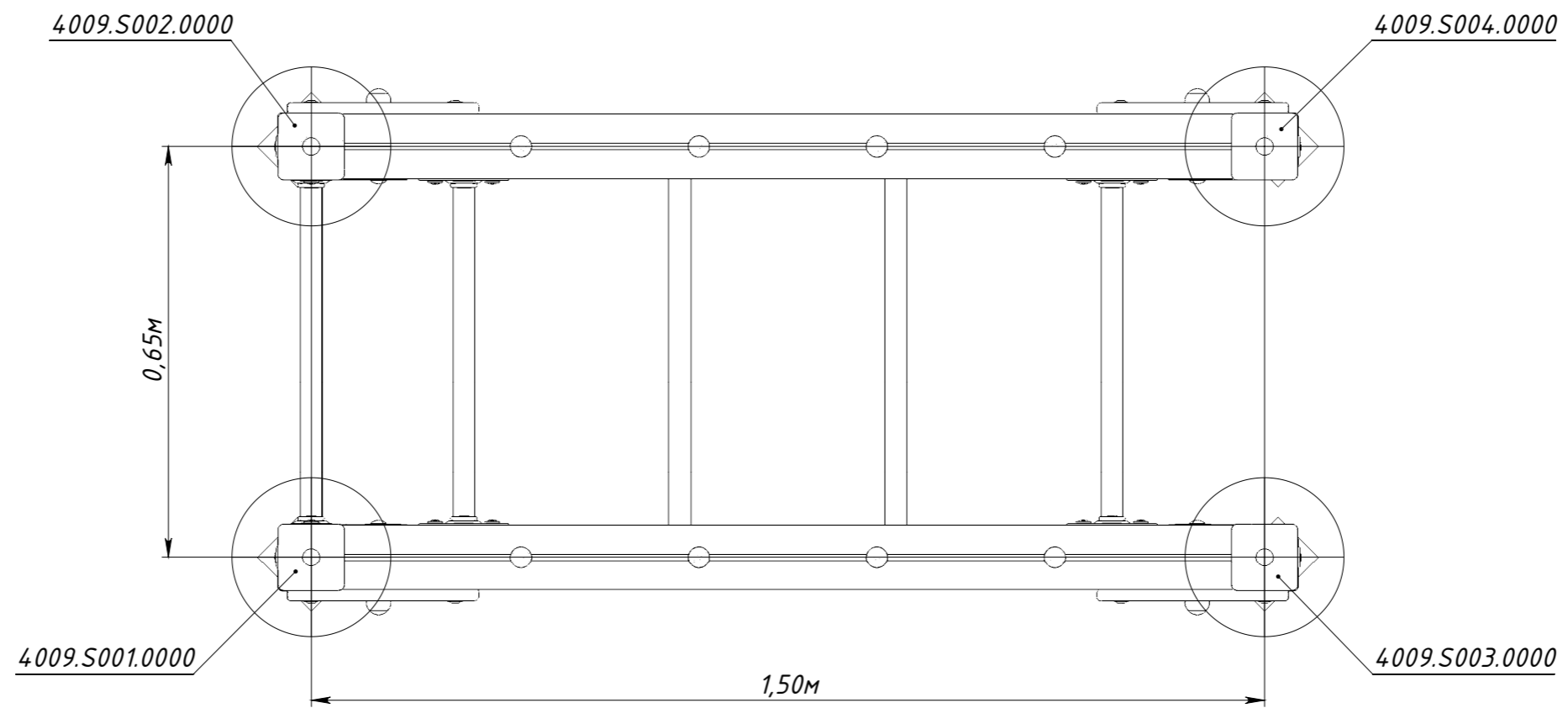

Рисунок 1