

Схема скважин
6118.0000.0000

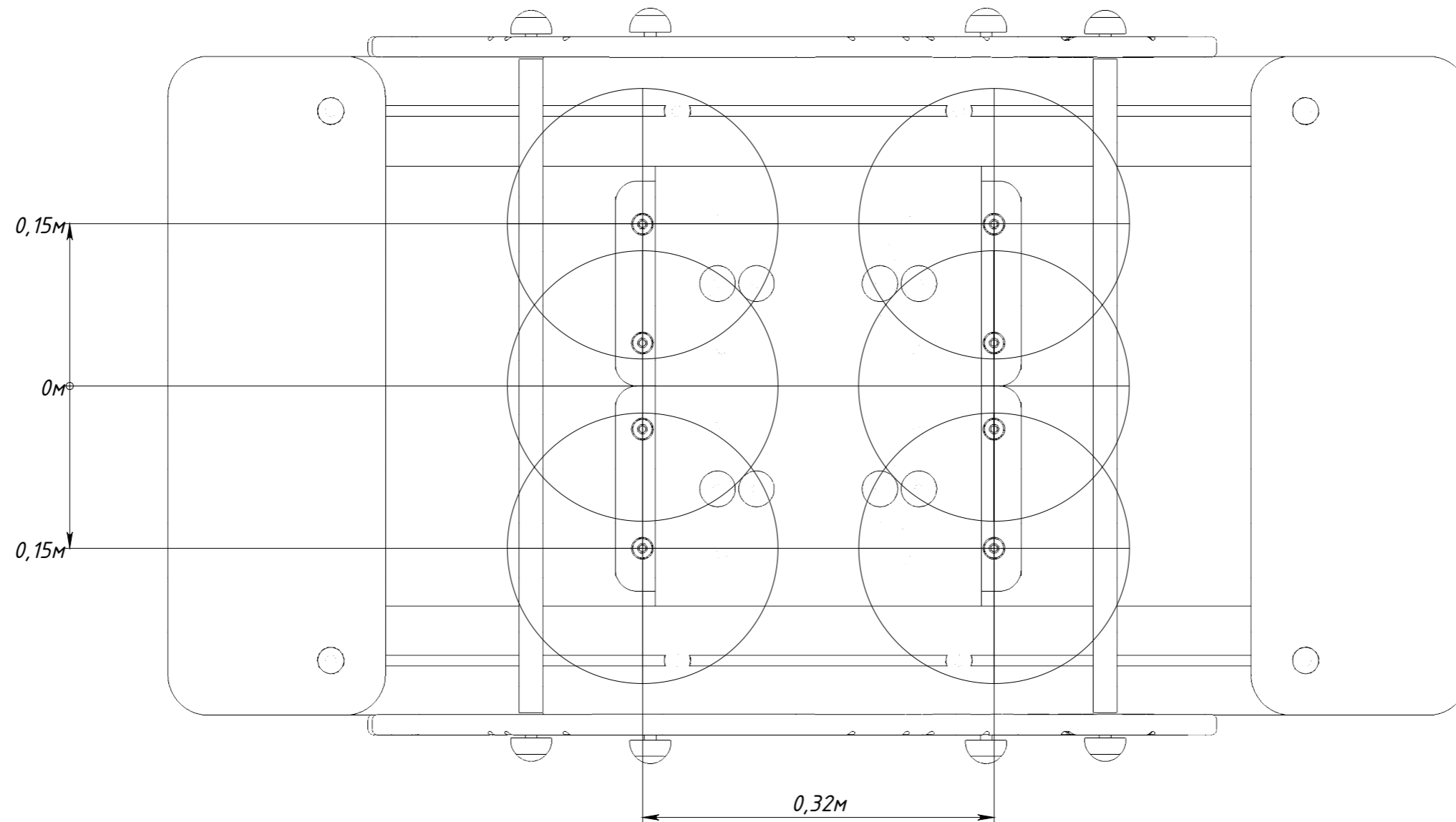

Рисунок 1