

Схема скважин
E6309.0000.0000

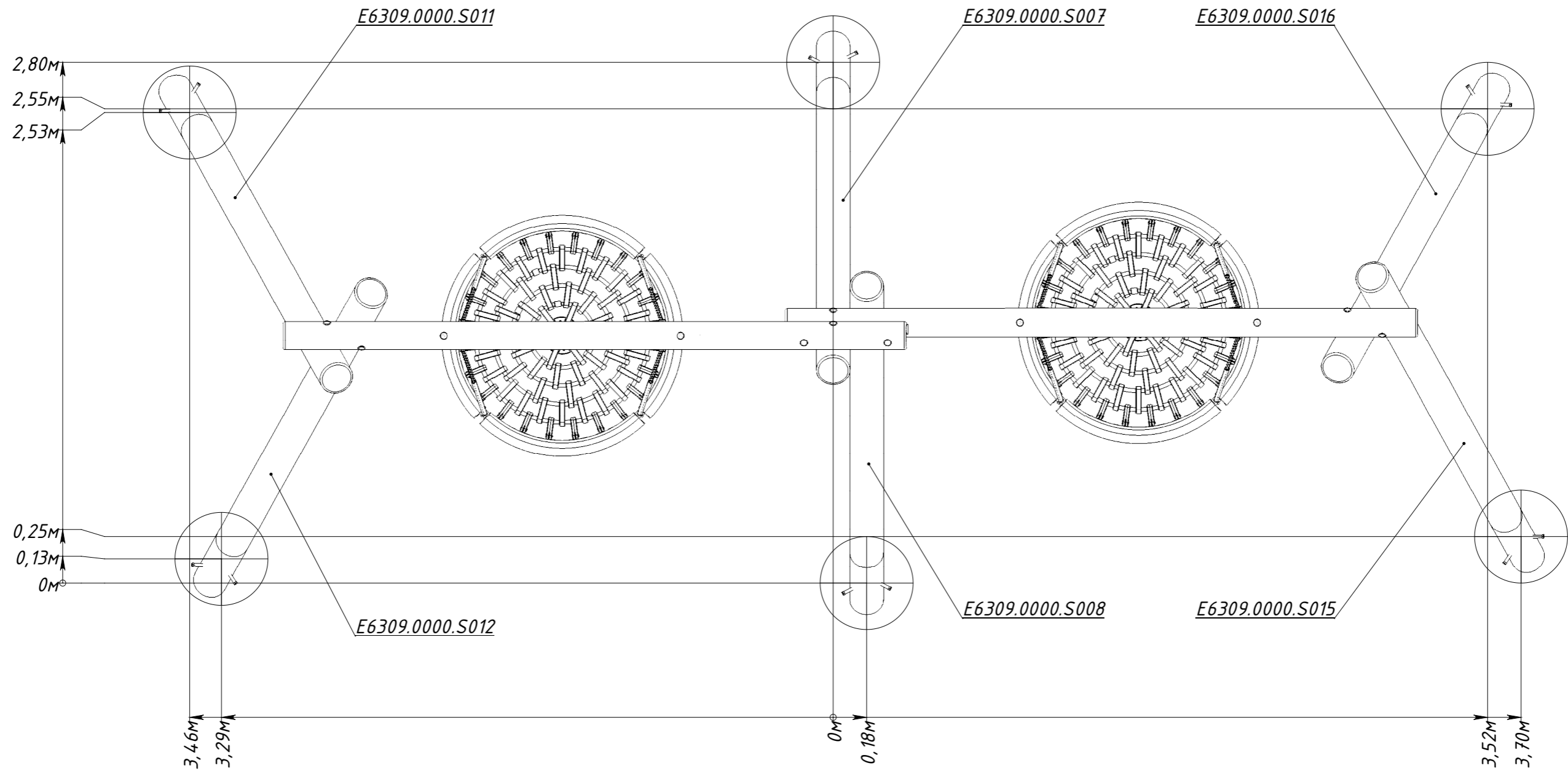

Рисунок 1