

Схема скважин
7820.0000.0000

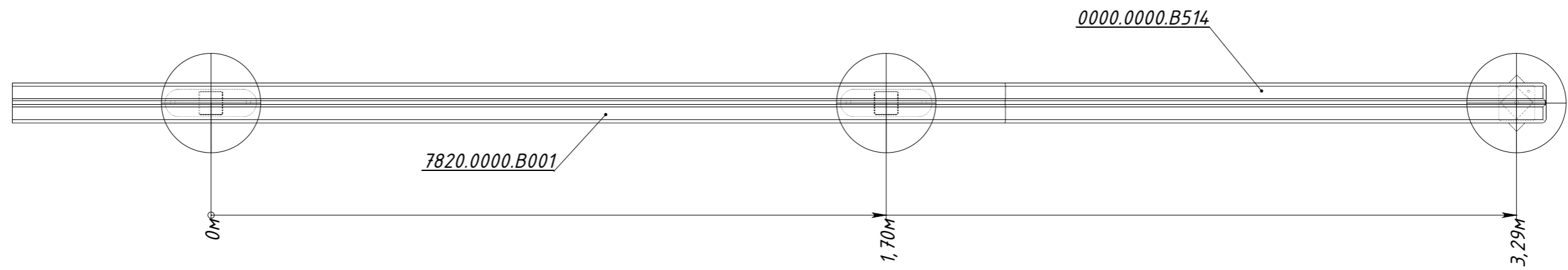

Рисунок 1