

Схема скважин
6109.0000.0000

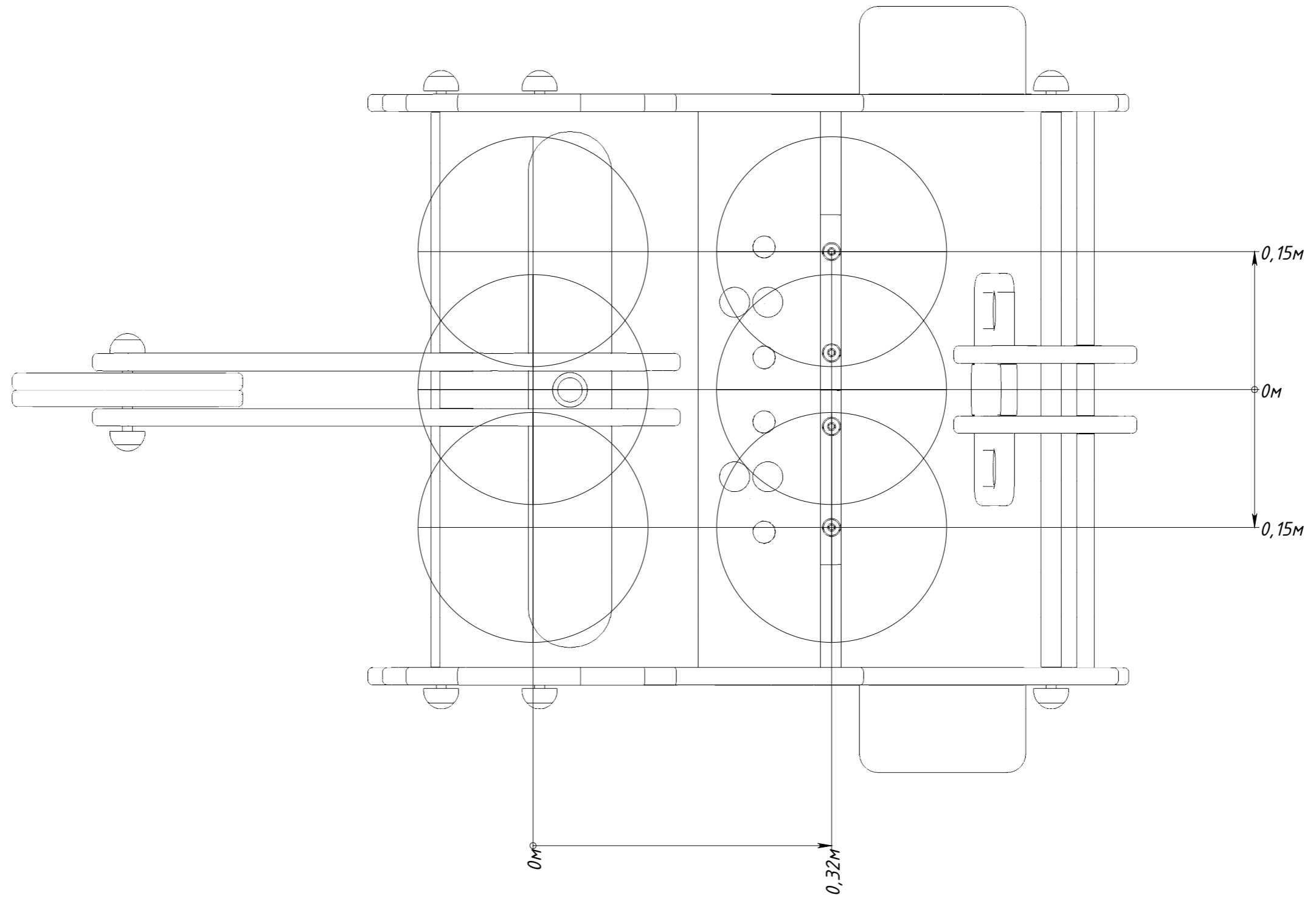

Рисунок 1