

Схема скважин
E2101.0000.0000

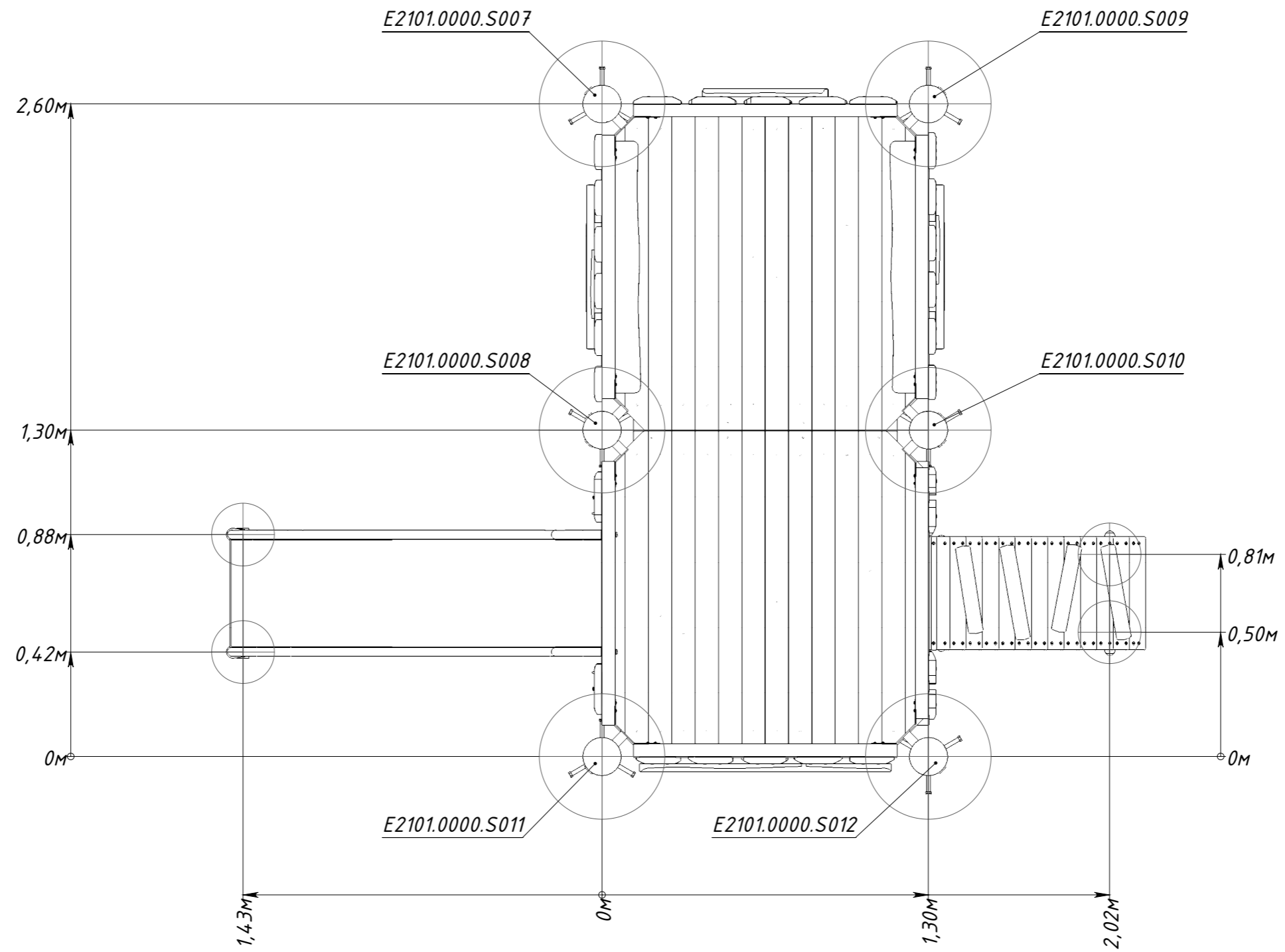

Рисунок 1