

**Схема скважин
7935.0000.0000**

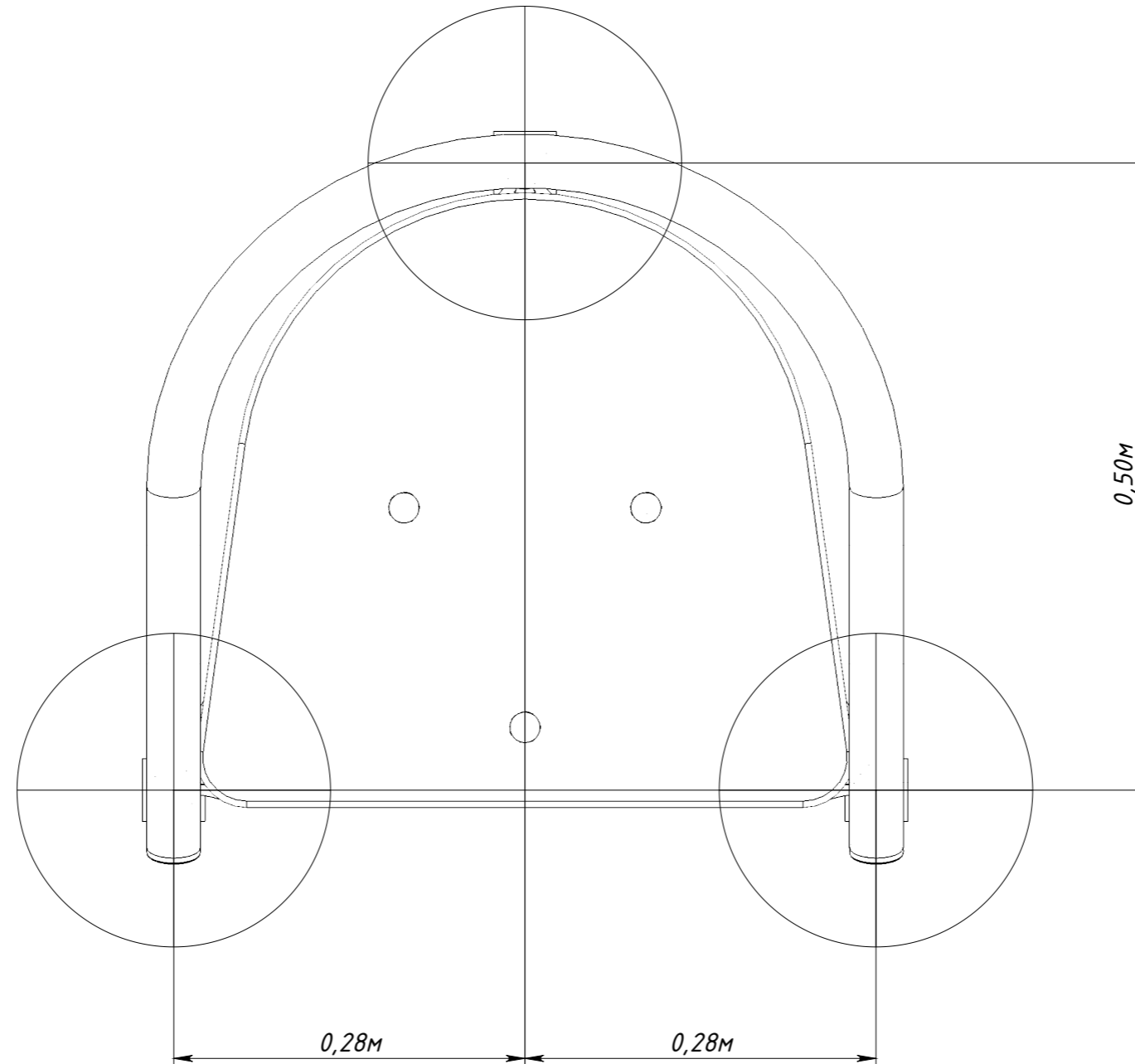

Рисунок 1