

Схема скважин
5306.0000.0000

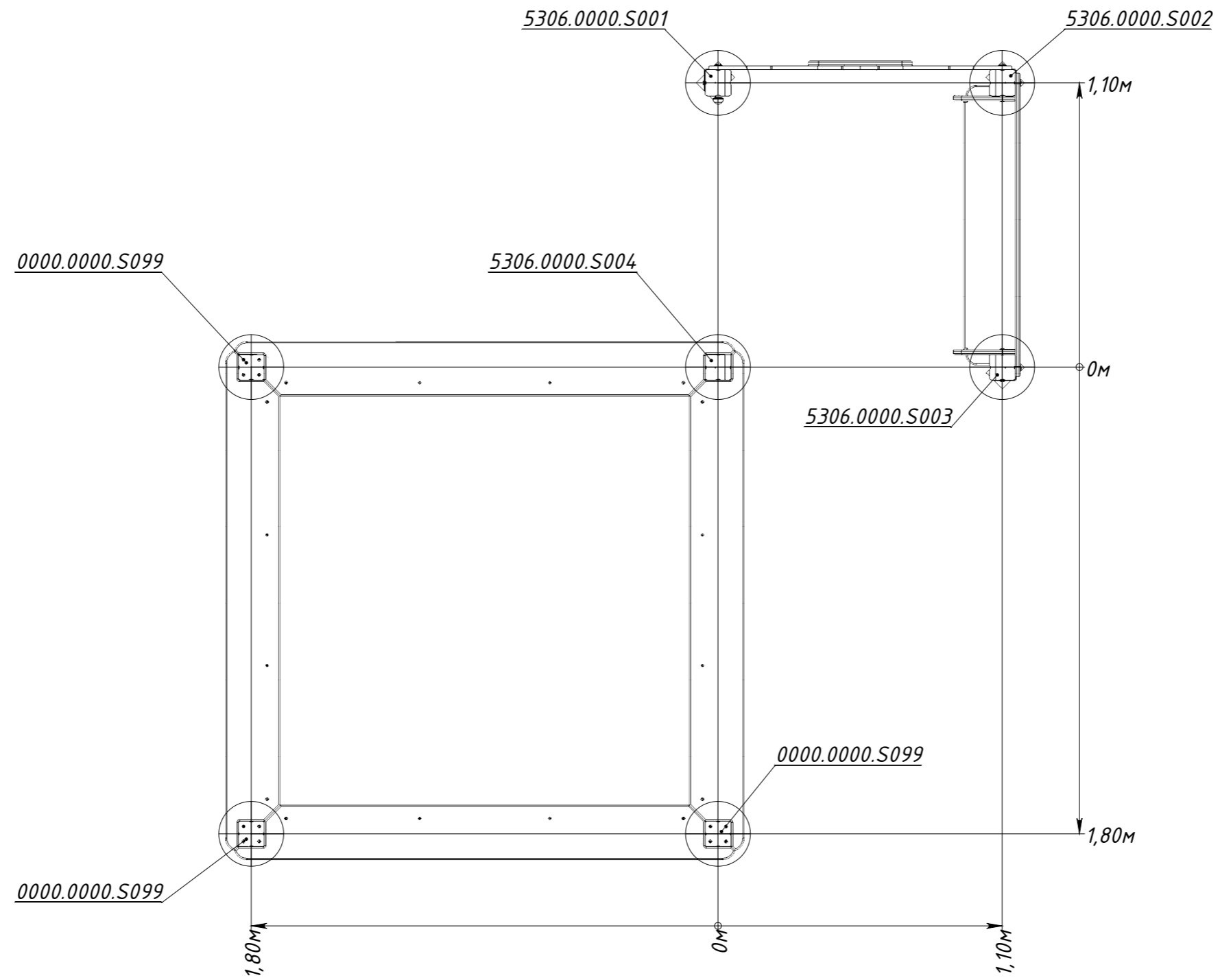

Рисунок 1