

Схема скважин
E6304.0000.0000

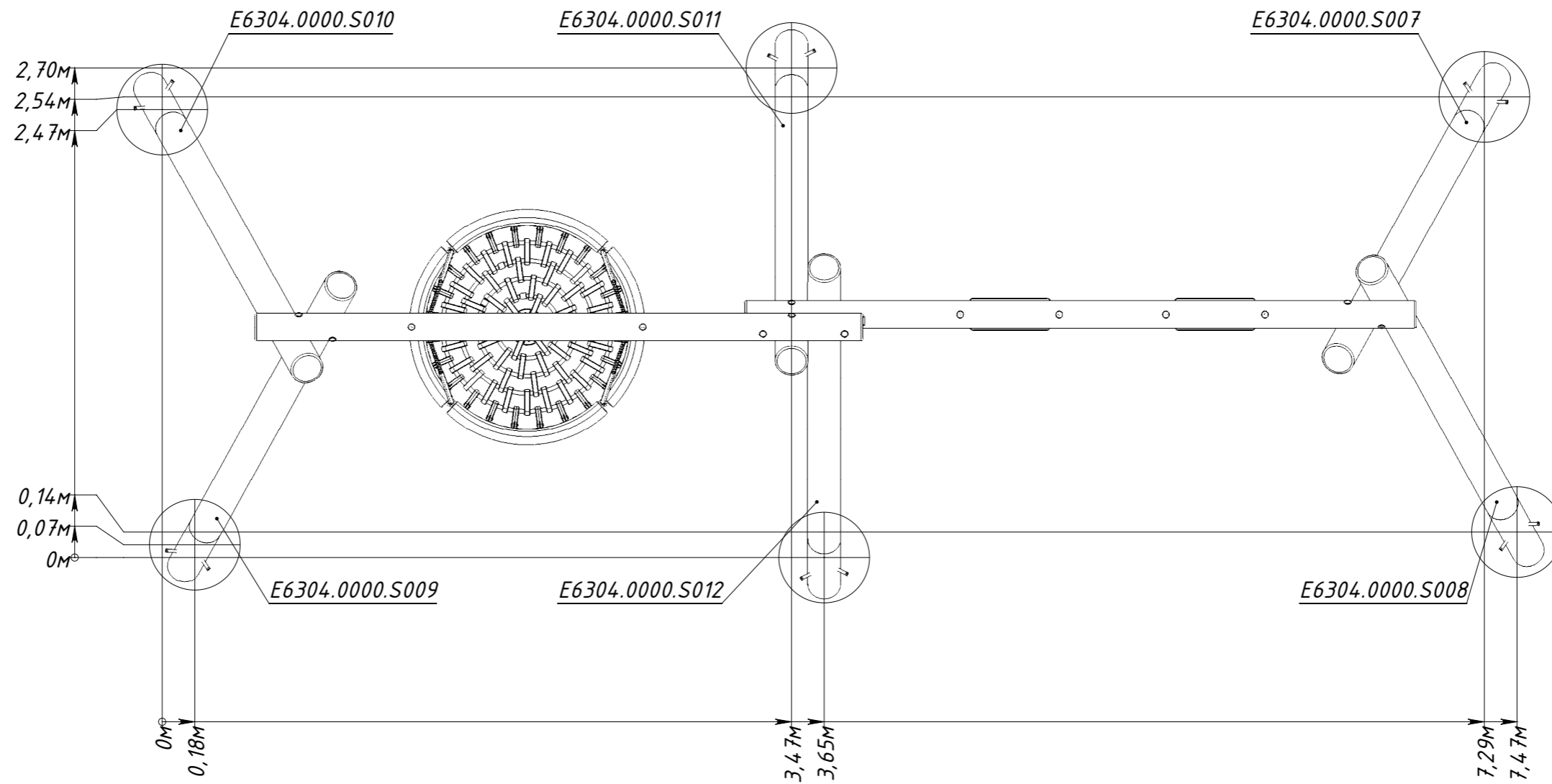

Рисунок 1