

**Схема скважин
Е6101.0000.0000**

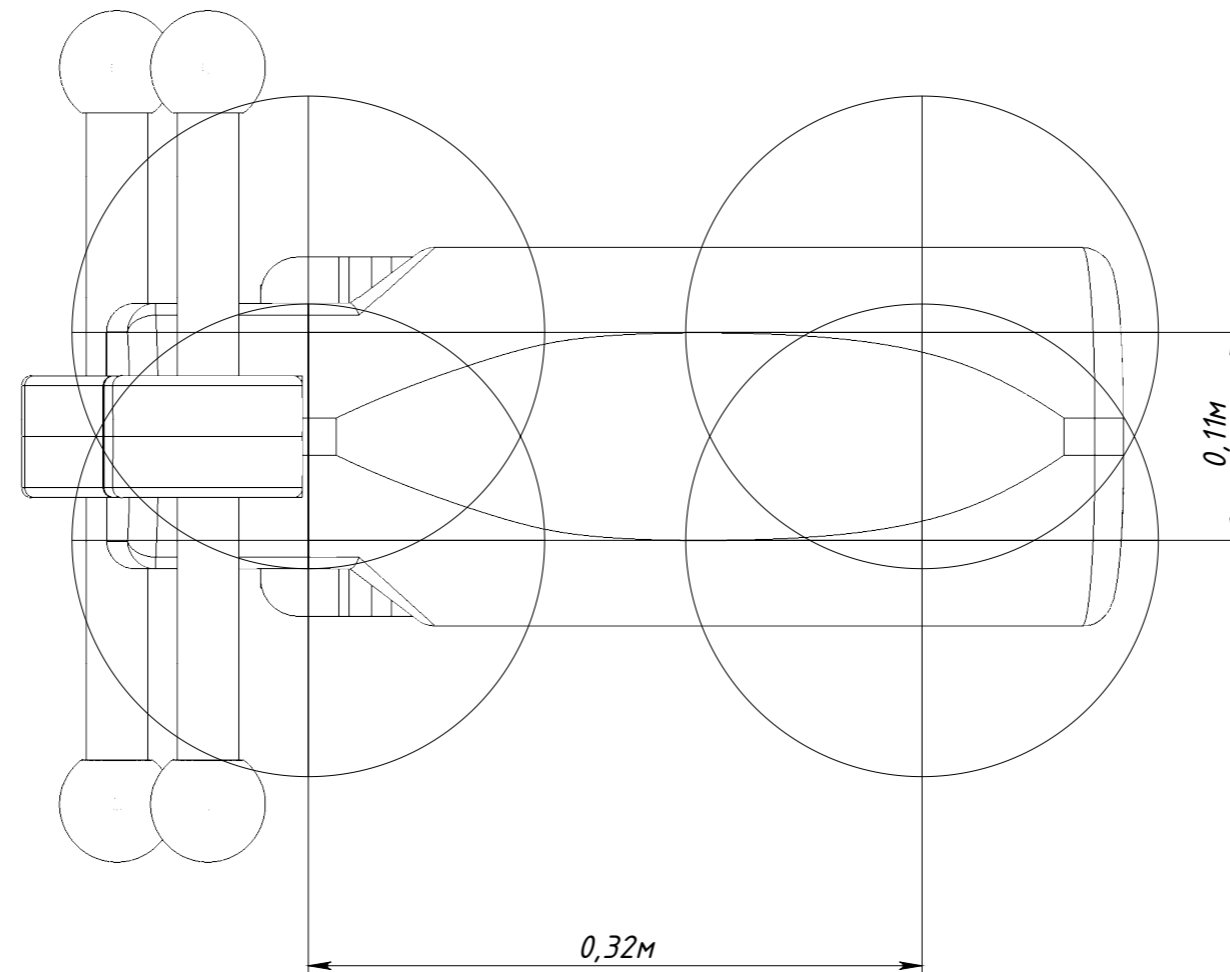

Рисунок 1