

**Инструкция по сборке
8016.0000.0000**







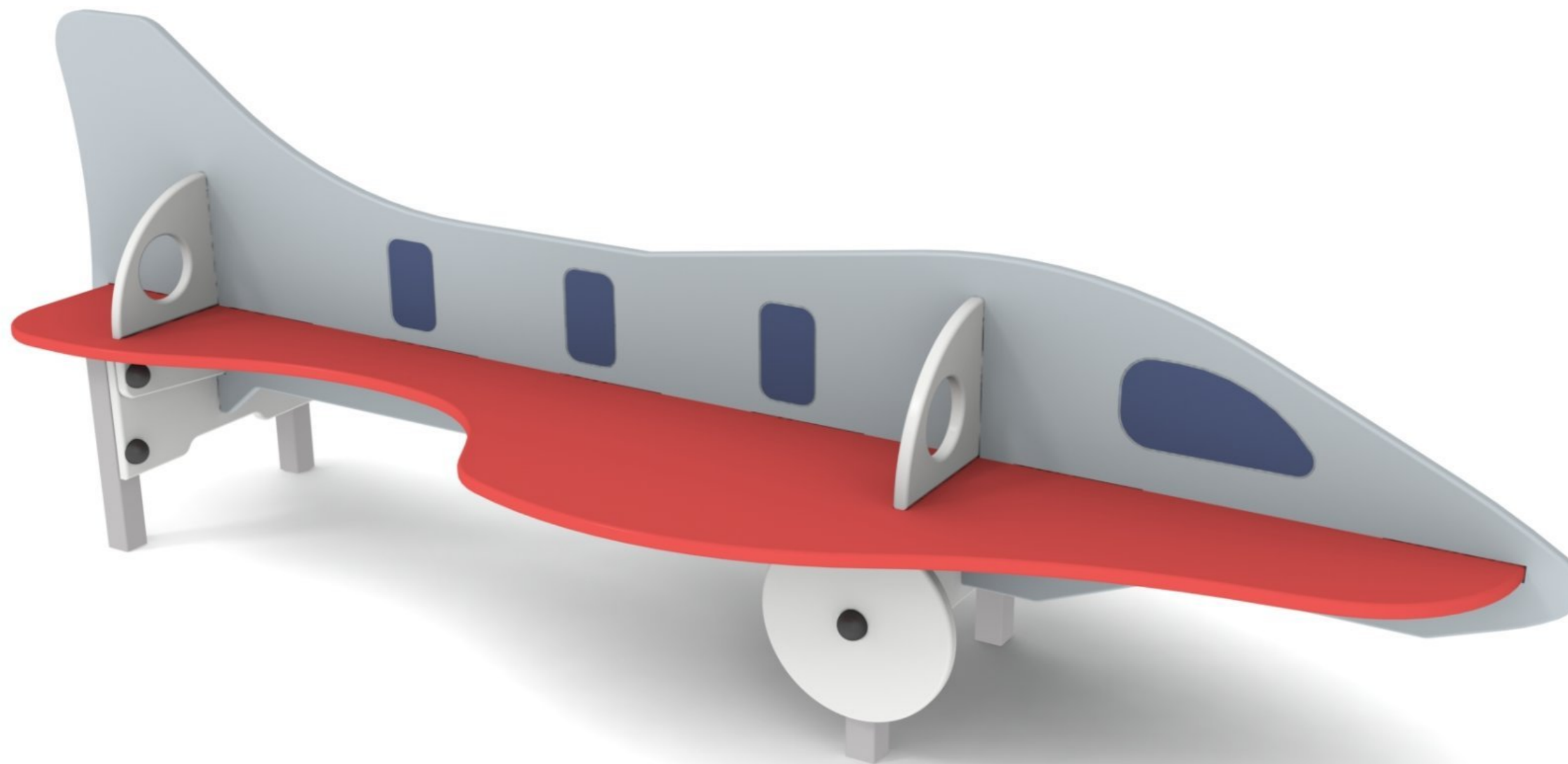
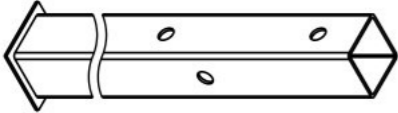
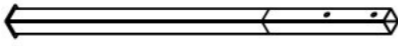
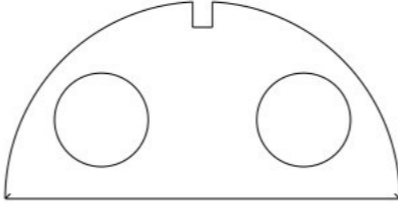
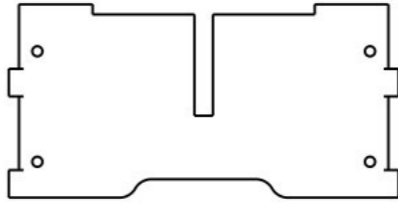

Таблица 1 — Составные части оборудования

 <p>0000.0413.0000 — 2 шт</p>	 <p>0000.0416.0000 — 2 шт</p>	 <p>0000.0000.6324 — 2 шт</p>	 <p>0000.0000.6325 — 1 шт</p>	 <p>0000.0000.6326 — 2 шт</p>
 <p>0000.0000.6327 — 1 шт</p>	 <p>0000.0000.7410 — 2 шт</p>	 <p>8016.0000.0002 — 1 шт</p>	 <p>8016.0000.0005 — 1 шт</p>	 <p>8016.0000.0006 — 1 шт</p>
 <p>STP.0004 (Колпачок защитно-декор., пластик., M10, Ø37 мм) — 10 шт</p>	 <p>STP.0005 (Заглушка колпачка защитно-декор., пластик., M10, Ø37 мм) — 10 шт</p>	 <p>STP.0013 (Заглушка квадратная, пластик., 40×40 мм) — 4 шт</p>	 <p>BF10.070.D603 (Болт меб., с квадр. подголовником, M10×70, DIN 603) — 6 шт</p>	 <p>BF10.090.D603 (Болт меб., с квадр. подголовником, M10×90, DIN 603) — 4 шт</p>

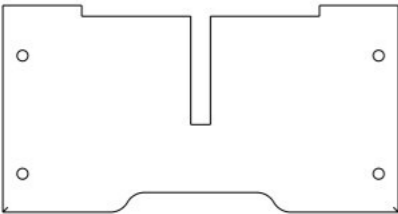
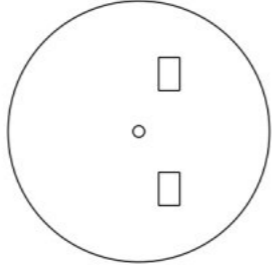
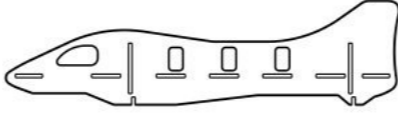

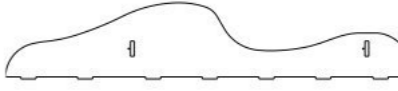
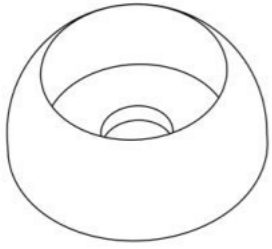
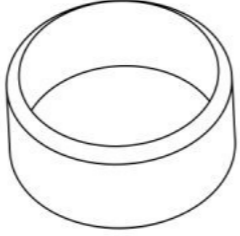
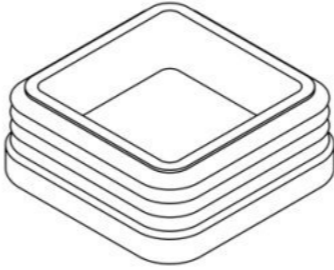
NF10.D6923 (Гайка с фланцем, M10,
DIN 6923) — 10 шт



SS05.050.D7982 (Винт самонар.,
потай., 5x50, DIN 7982) — 4 шт



Рисунок 1



Рисунок 2

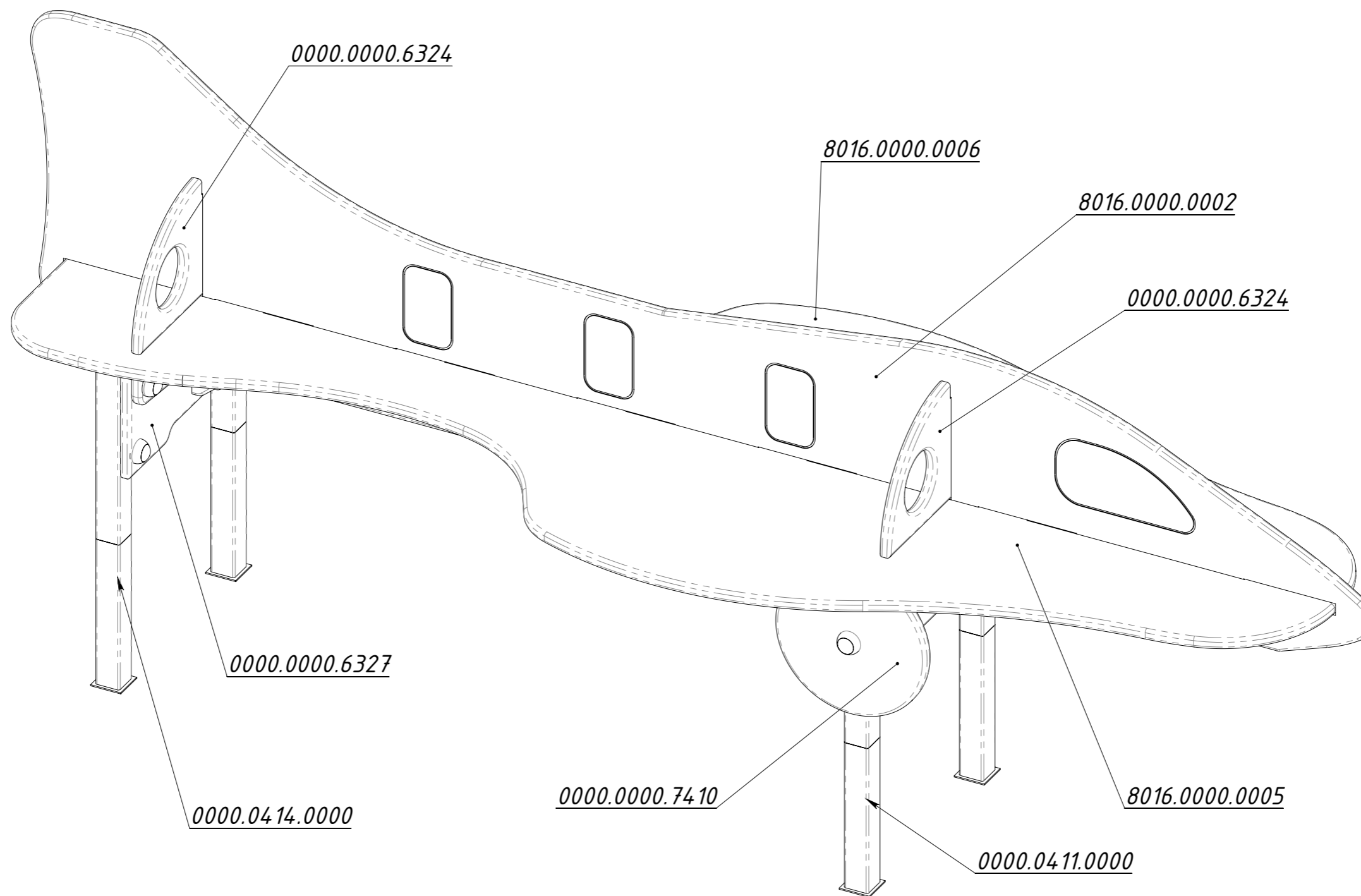
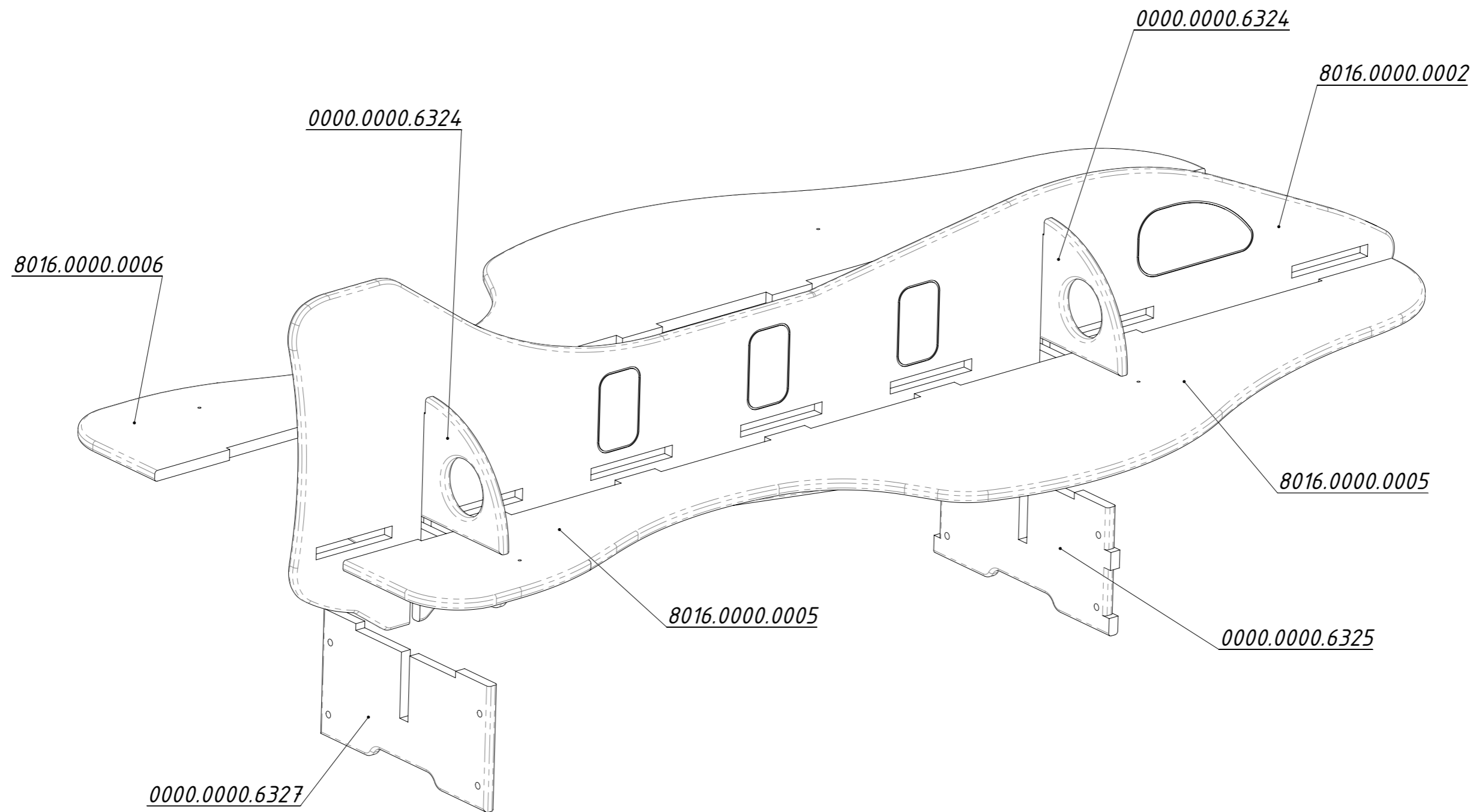
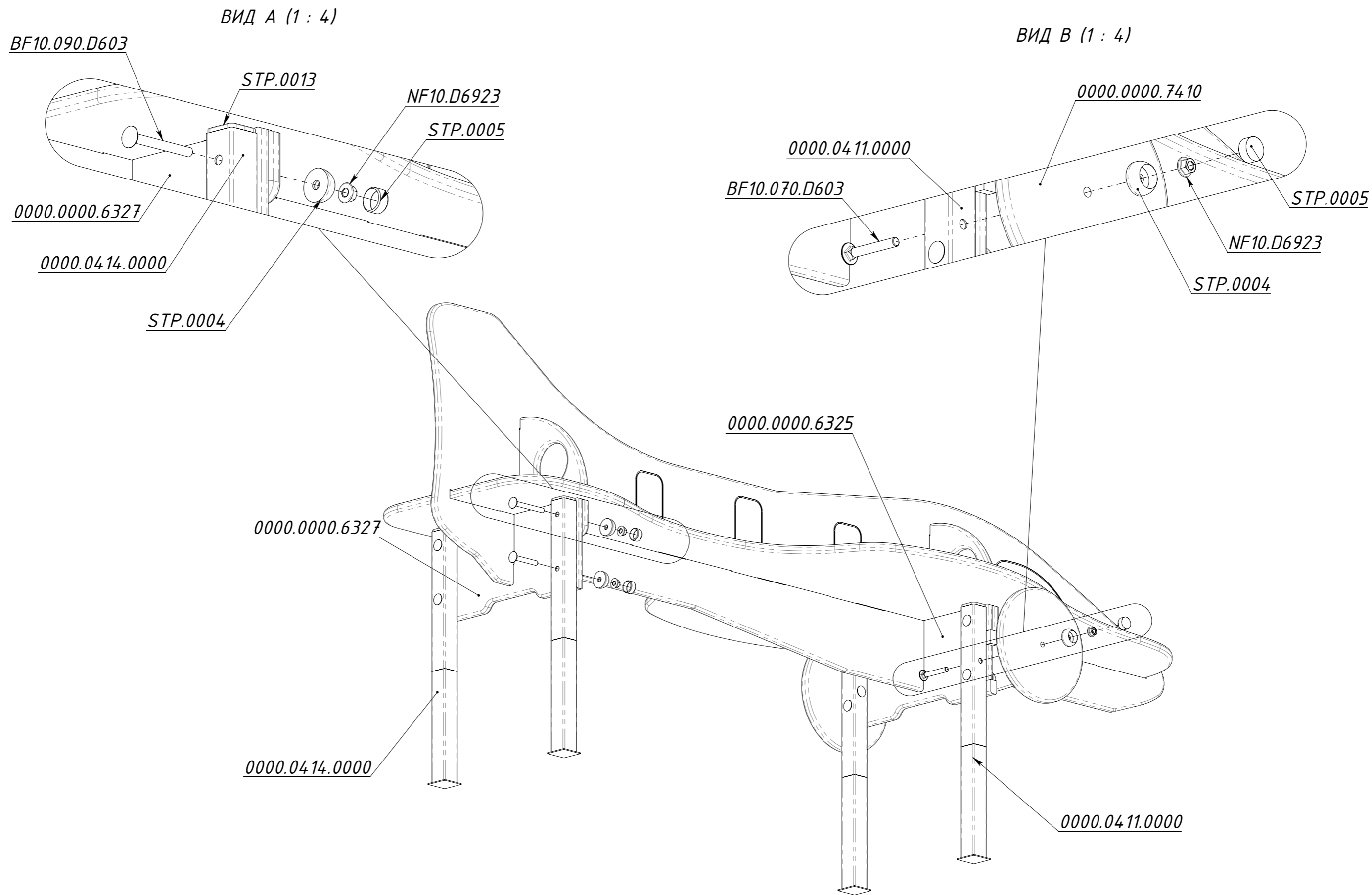

Рисунок 3