

Схема скважин
E2105.0000.0000

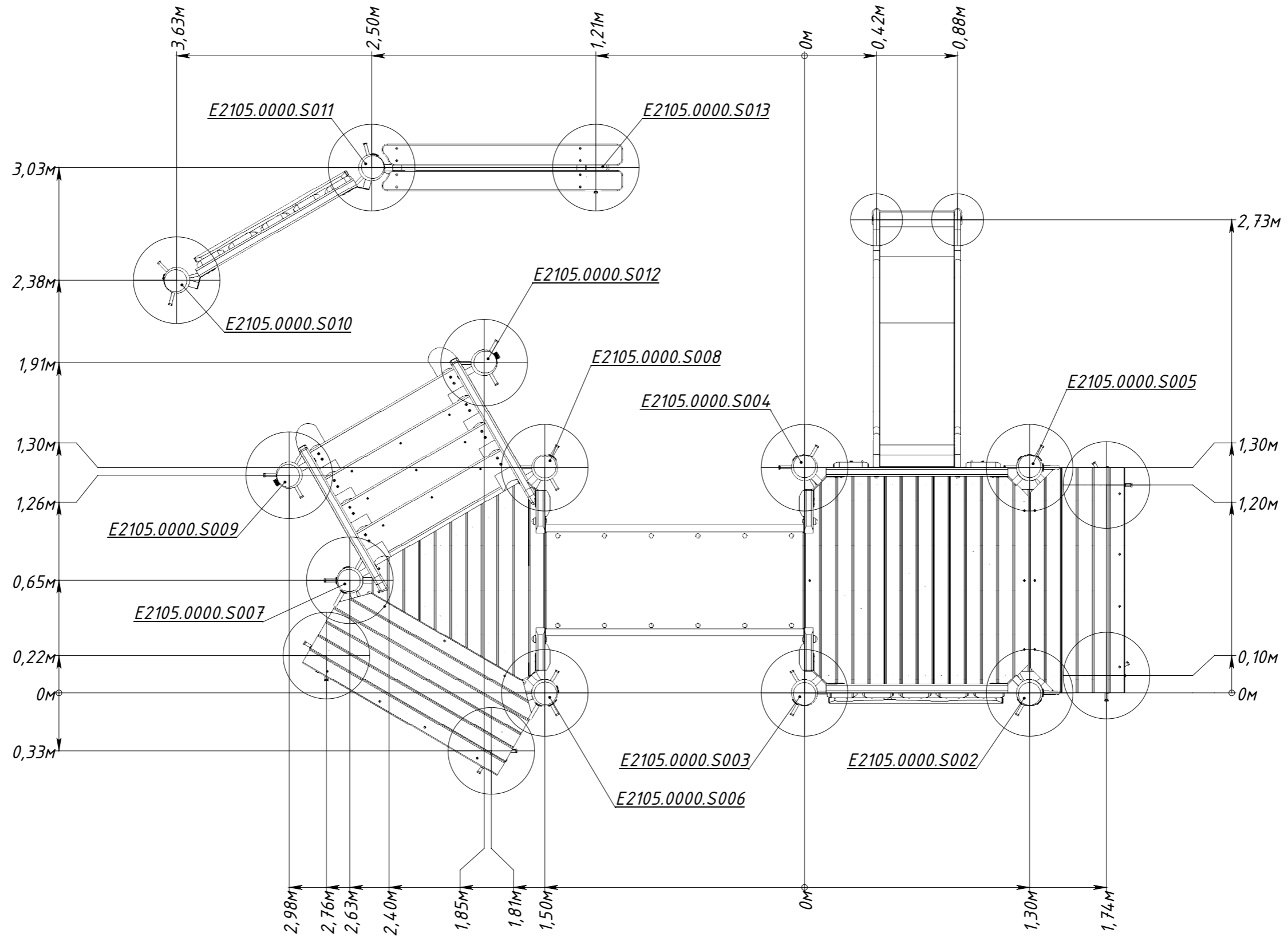

Рисунок 1