

Схема скважин
E6202.0000.0000

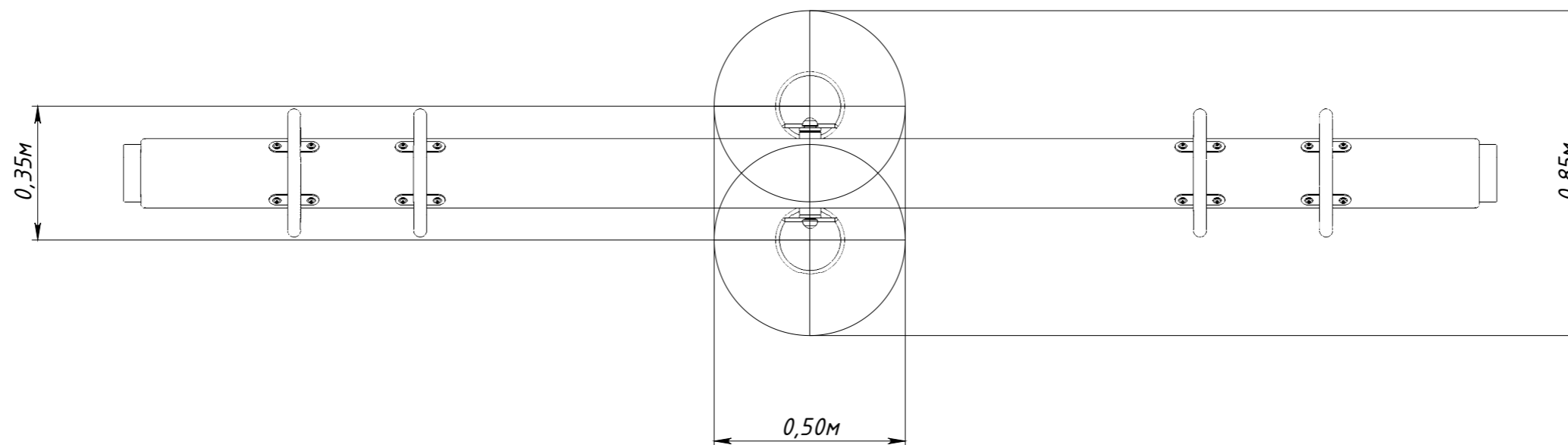

Рисунок 1