

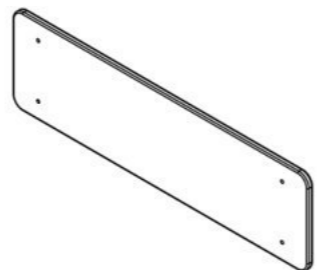

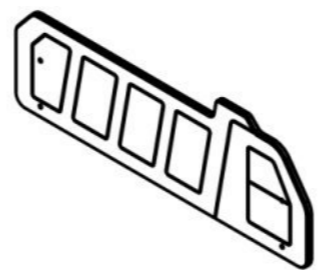



**Инструкция по сборке
8048.0000.0000**



Таблица 1 — Составные части оборудования

 <p>0000.6111.0000 — 1 шт</p>	 <p>0000.0000.6019 — 1 шт</p>	 <p>8048.0000.0001 — 1 шт</p>	 <p>STR.0020 (Заглушка прямоугольная, пластик, 40×20 мм) — 2 шт</p>	 <p>BF10.070.D603 (Болт меб., с квадр. подголовником, M10×70, DIN 603) — 8 шт</p>
 <p>ND10.D1587 (Гайка колпачковая, M10, DIN 1587) — 8 шт</p>	 <p>WP10.D125 (Шайба плоская, M10, DIN 125) — 8 шт</p>	 <p>WS10.D127 (Шайба гроверная, M10, DIN 127) — 8 шт</p>		

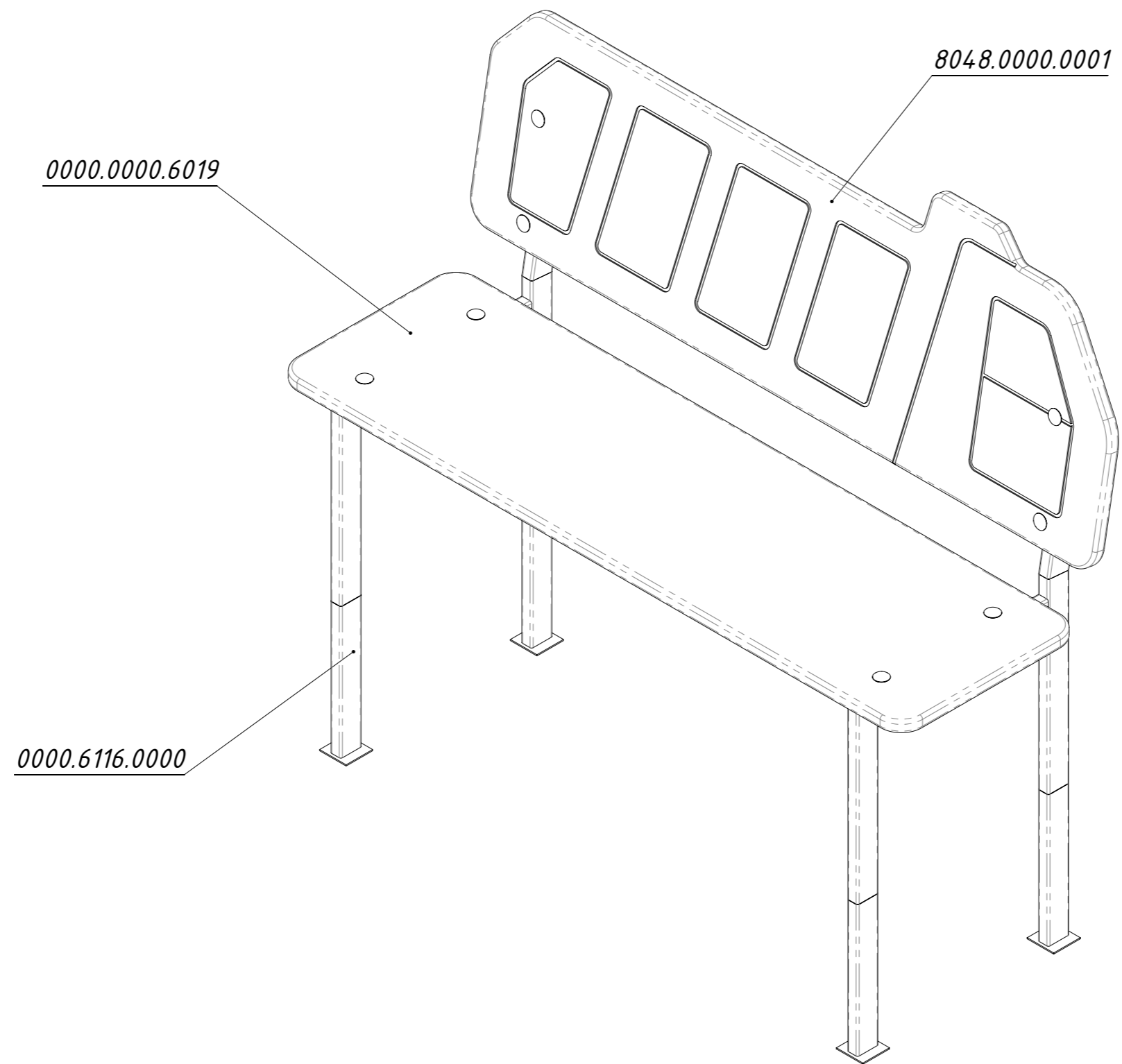

Рисунок 1

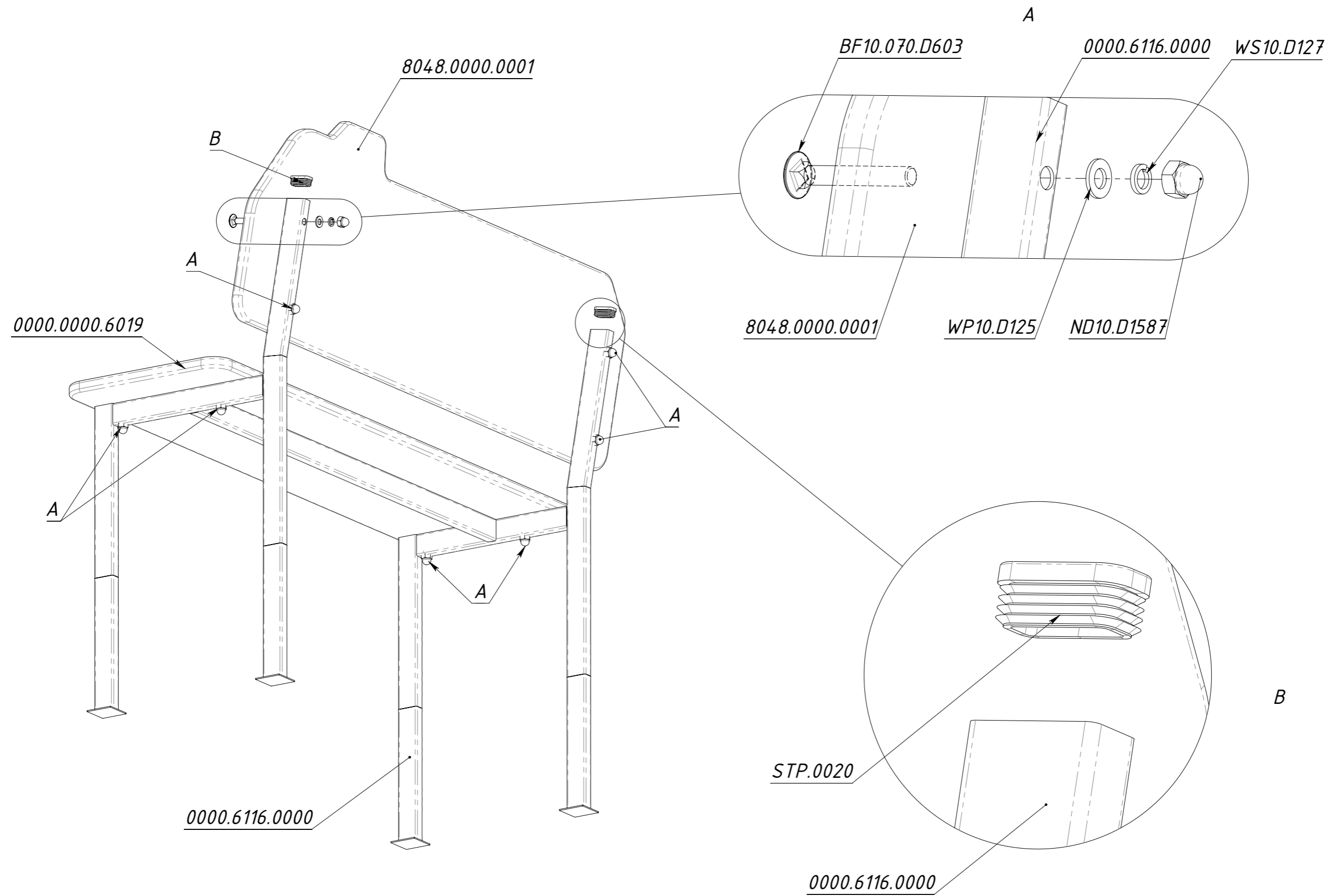

Рисунок 2