

Схема скважин
E5004.0000.0000

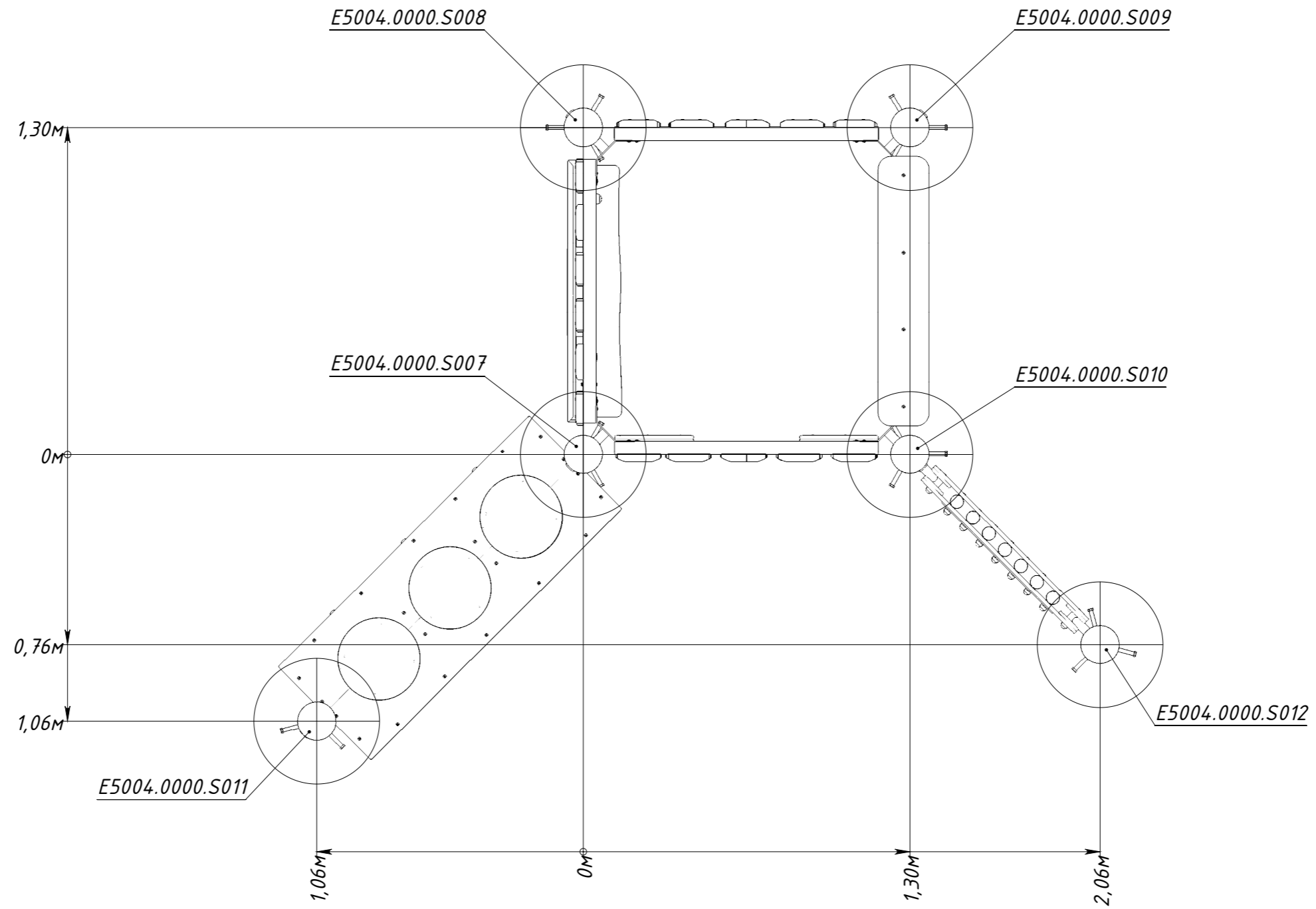

Рисунок 1