

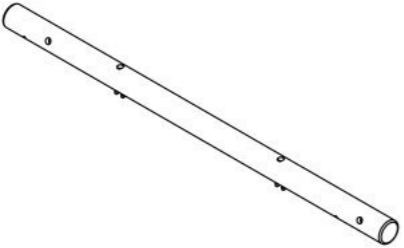

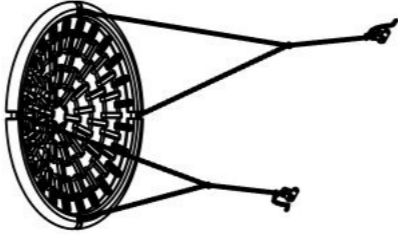





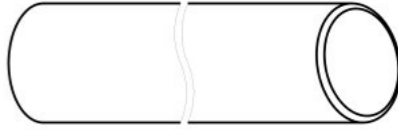

Инструкция по сборке
E6302.0000.0000



Таблица 1 — Составные части оборудования

 <p>0000.3136.0000 — 1 шт</p>	 <p>0000.3208.0000 — 1 шт</p>	 <p>E6302.0000.S005 — 1 шт</p>	 <p>E6302.0000.S006 — 1 шт</p>	 <p>E6302.0000.S007 — 1 шт</p>
 <p>E6302.0000.S008 — 1 шт</p>	 <p>0000.0000.0584 — 6 шт</p>	 <p>STP.0104 (Заглушка круглая, пластик., Ø40 мм) — 12 шт</p>	 <p>NT12.D985 (Гайка с пластиковой вставкой, M12, DIN 985) — 12 шт</p>	 <p>SH12.100.D571 (Винт самонар., с шестигр. головкой, 12×100, DIN 571) — 12 шт</p>
 <p>SO08.080 (Винт самонар., полусфер., с пресс-шайбой, TORX, 8×80) — 2 шт</p>	 <p>WP12.A2.D9021 (Шайба увеличенная, нерж., M12, DIN 9021) — 12 шт</p>			



Рисунок 1



Рисунок 2

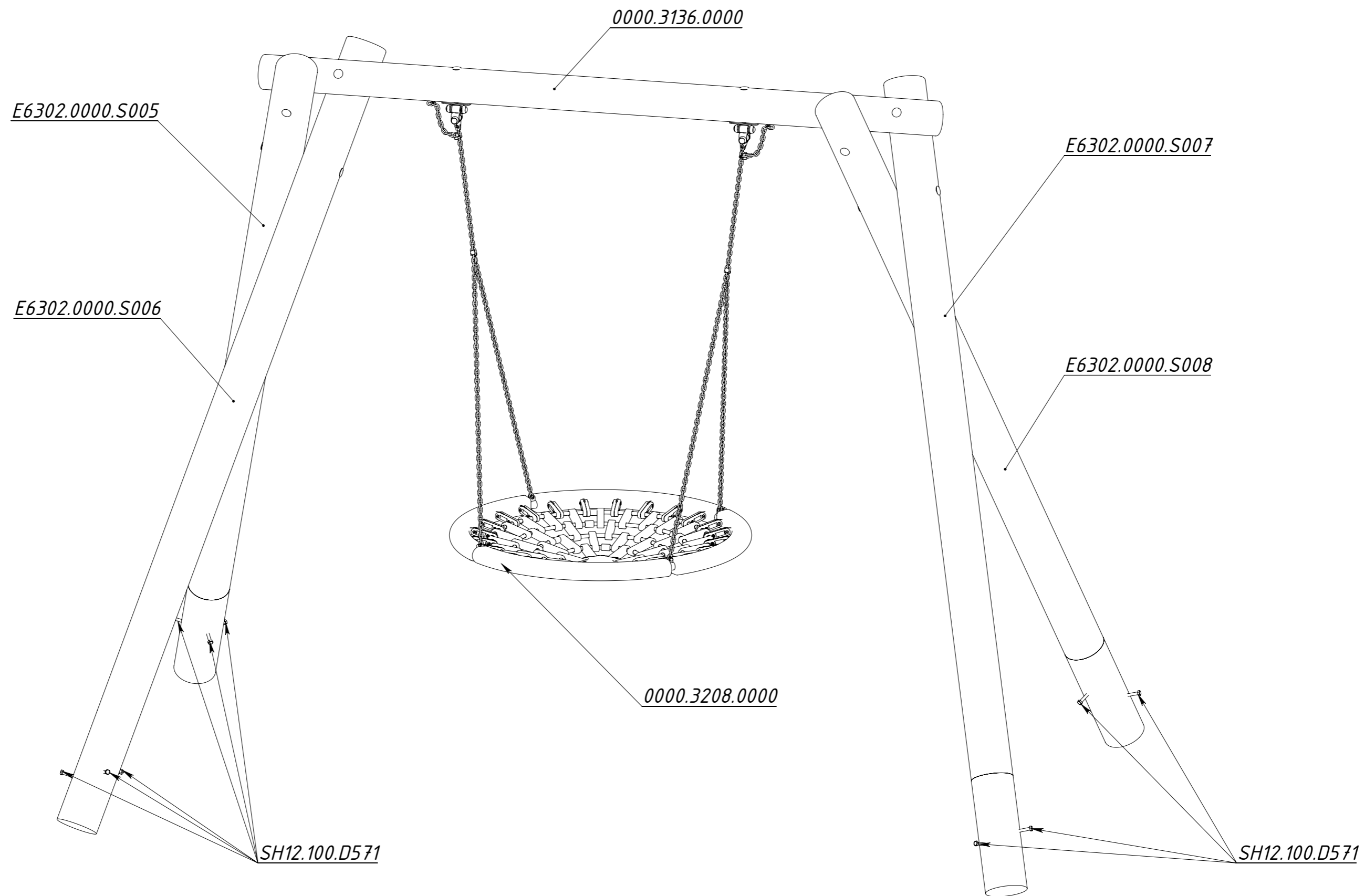
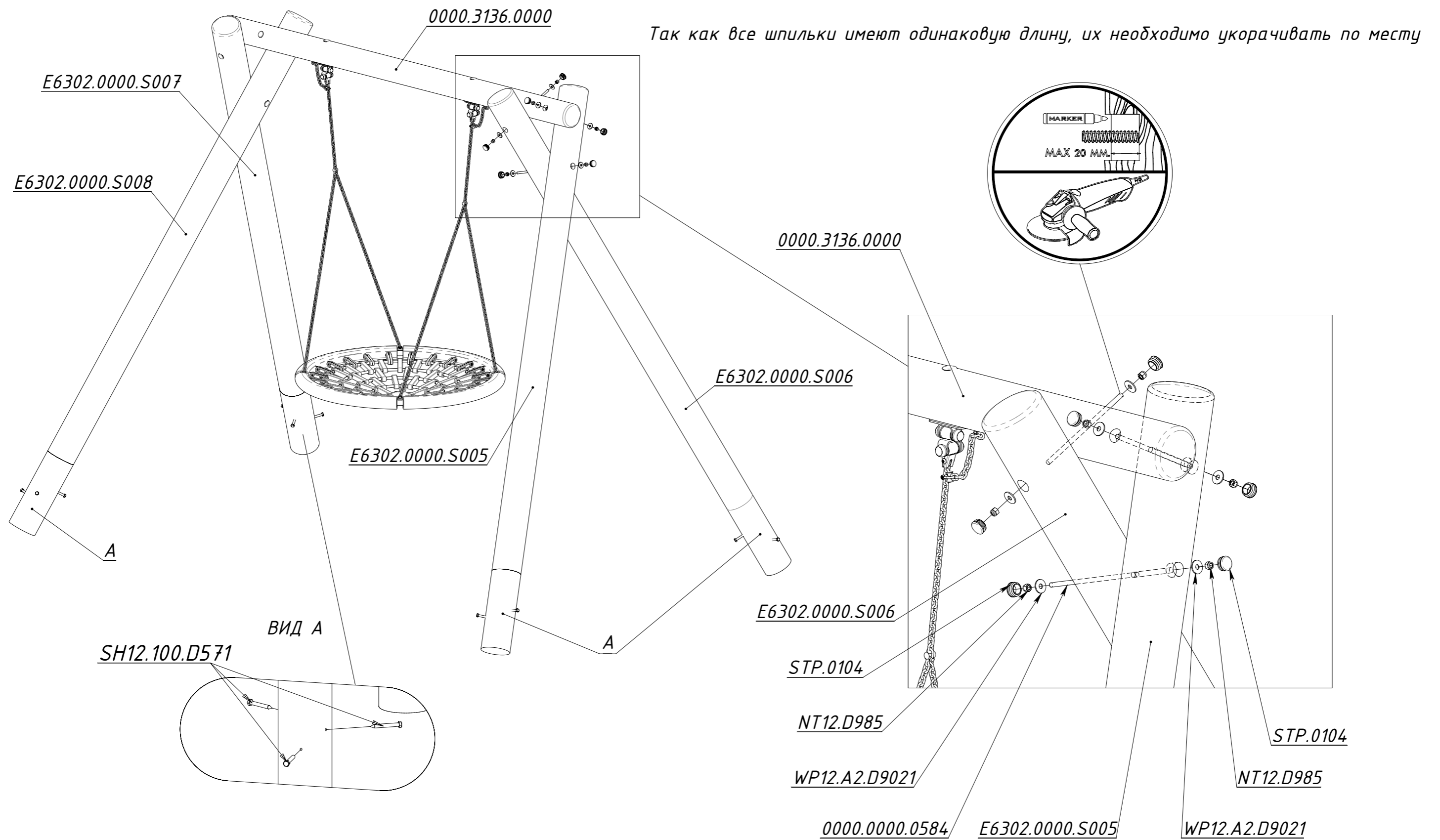
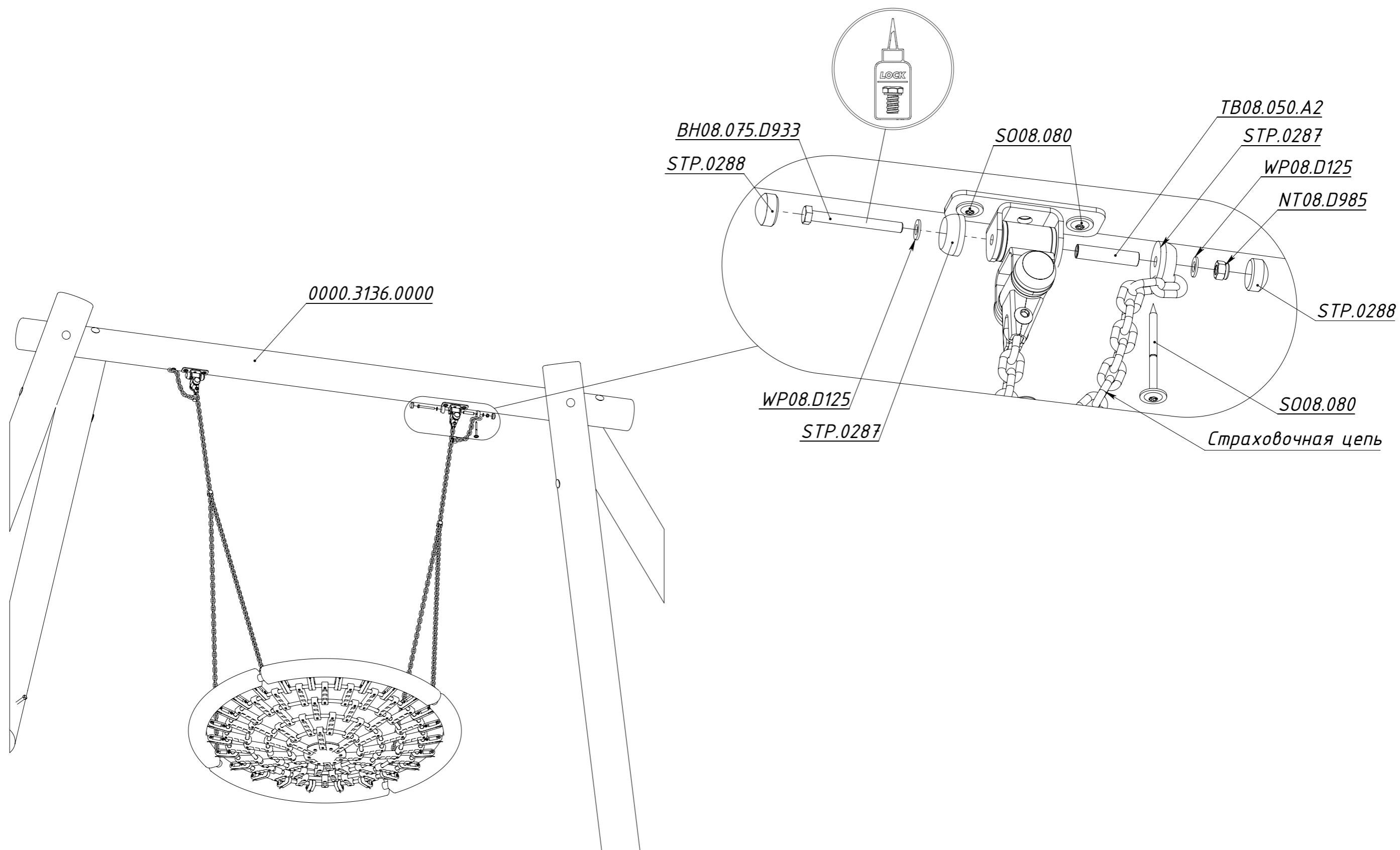

Рисунок 3