

Схема скважин
4027.0000.0000

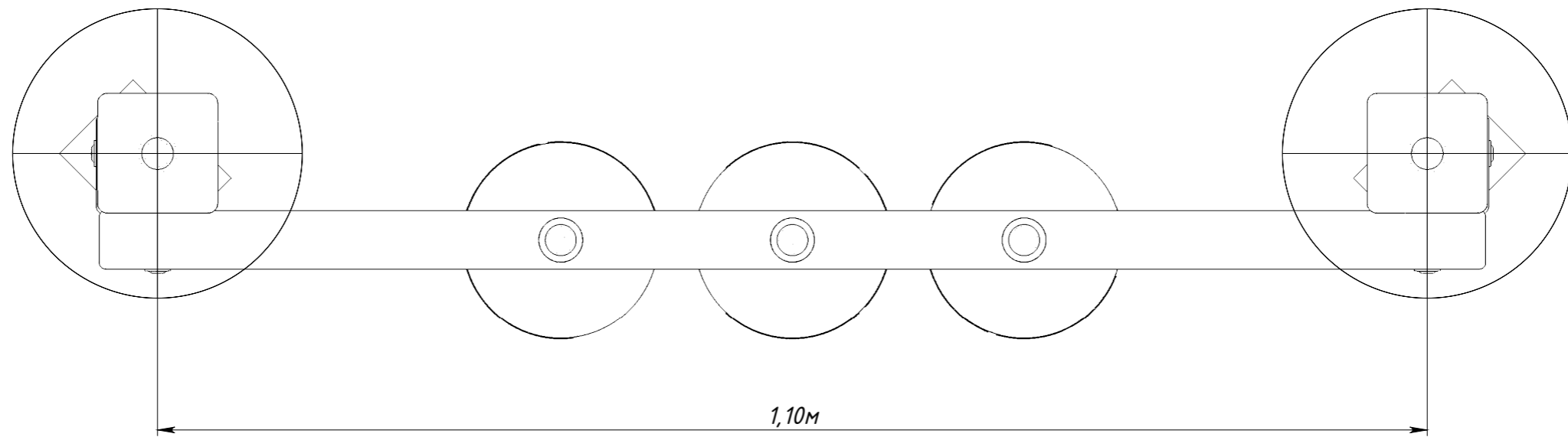

Рисунок 1