

Схема скважин
E6201.0000.0000

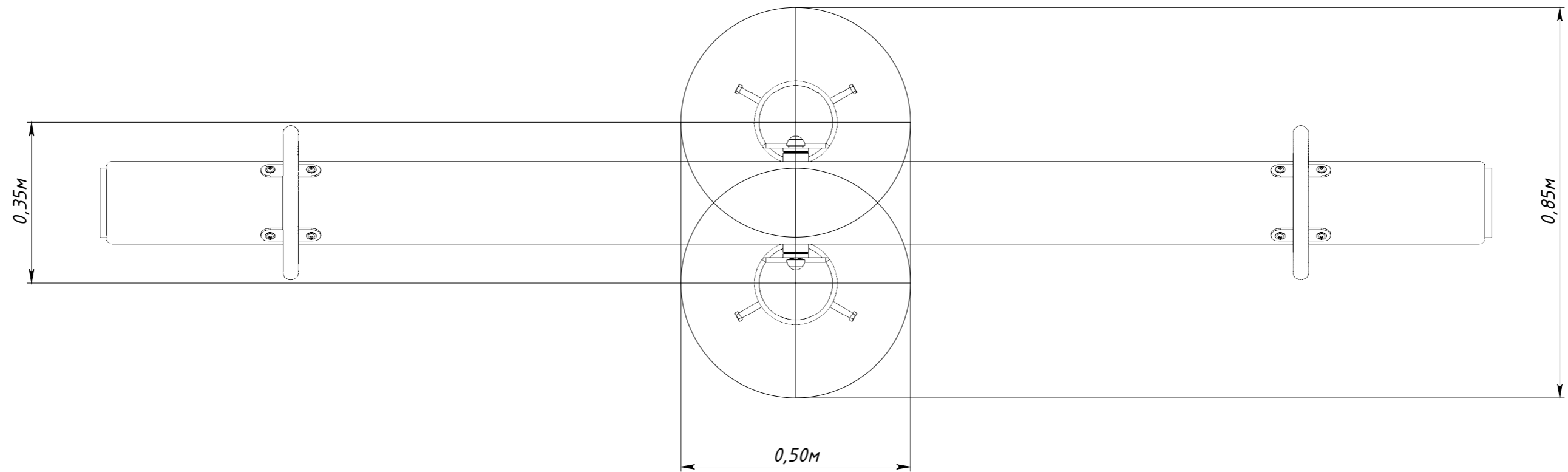

Рисунок 1