

Схема скважин
6114.0000.0000

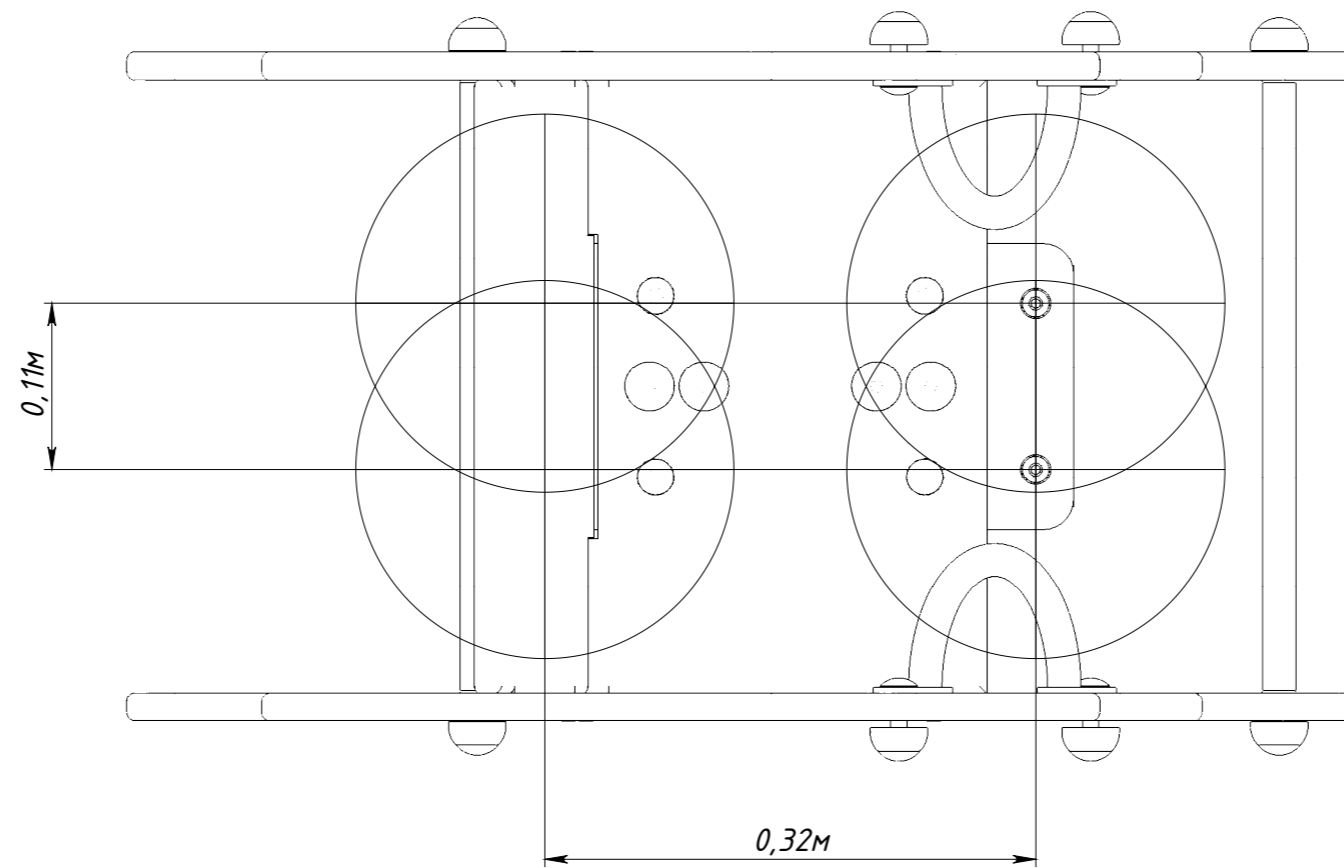

Рисунок 1