

Схема скважин
5328.0000.0000

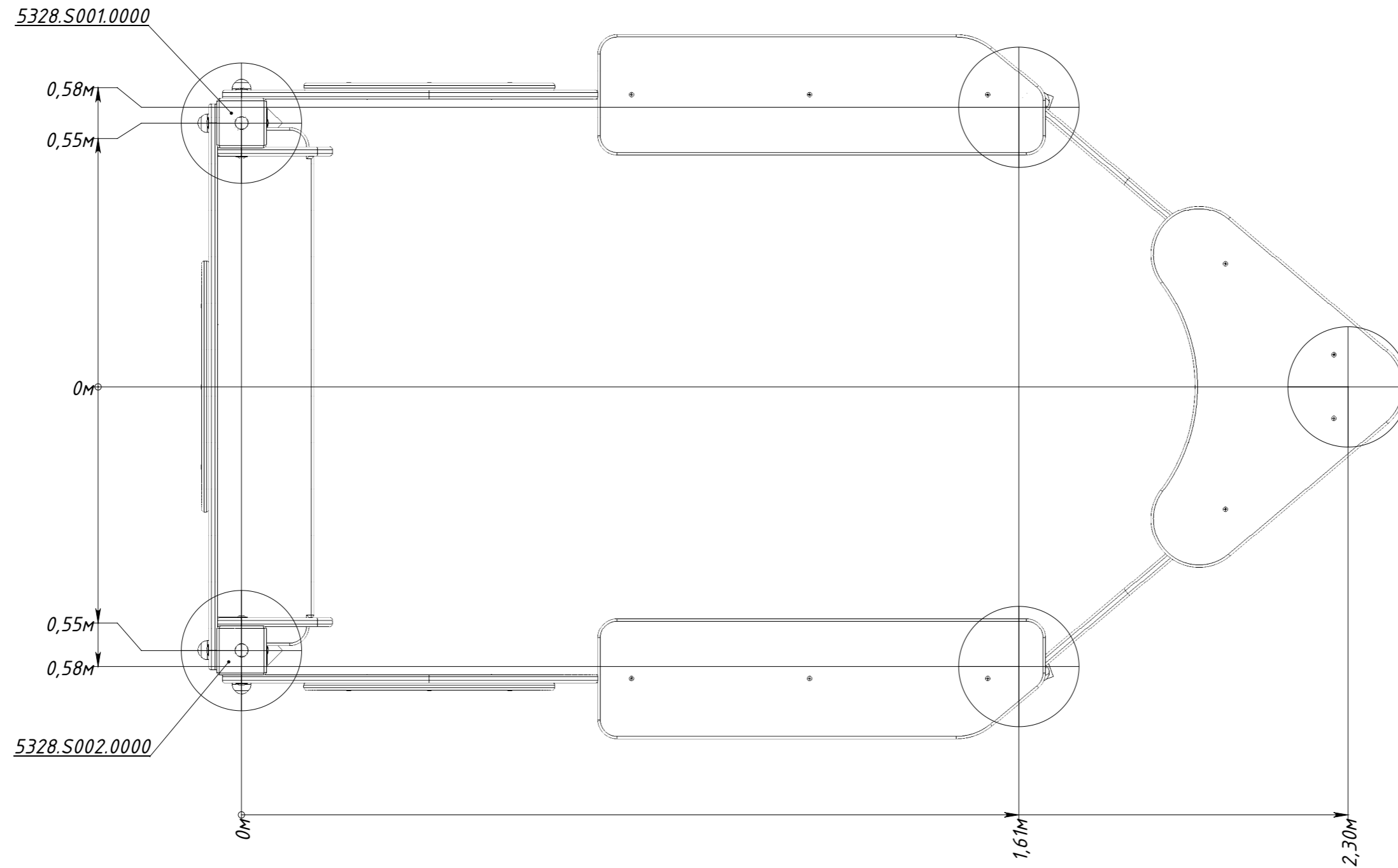

Рисунок 1