

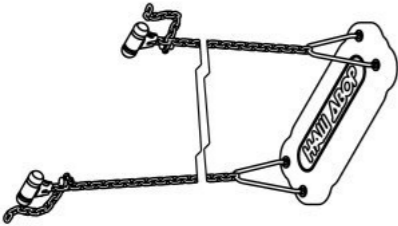

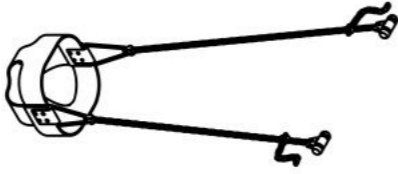

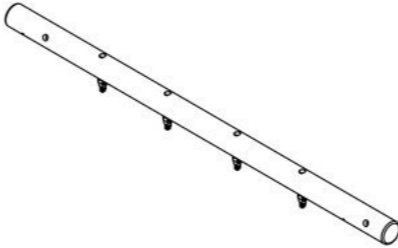



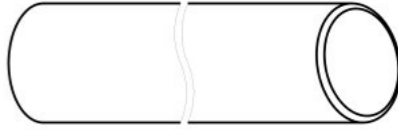

**Инструкция по сборке  
E6308.0000.0000**



Таблица 1 — Составные части оборудования

 <p>0000.3036.0000 — 1 шт</p>	 <p>0000.3169.0000 — 1 шт</p>	 <p>E6308.0001.0000 — 1 шт</p>	 <p>E6308.0000.S005 — 1 шт</p>	 <p>E6308.0000.S007 — 1 шт</p>
 <p>E6308.0000.S009 — 1 шт</p>	 <p>E6308.0000.S011 — 1 шт</p>	 <p>0000.0000.0584 — 6 шт</p>	 <p>STR.0104 (Заглушка круглая, пластик., Ø40 мм) — 12 шт</p>	 <p>NT12.D985 (Гайка с пластиковой вставкой, M12, DIN 985) — 12 шт</p>
 <p>SH12.100.D571 (Винт самонар., с шестигр. головкой, 12×100, DIN 571) — 12 шт</p>	 <p>SO08.080 (Винт самонар., полусфер., с пресс-шайбой, TORX, 8×80) — 4 шт</p>	 <p>WP12.A2.D9021 (Шайба увеличенная, нерж., M12, DIN 9021) — 12 шт</p>		



Рисунок 1

Так как все шпильки имеют одинаковую длину, их необходимо укорачивать по месту



Рисунок 2

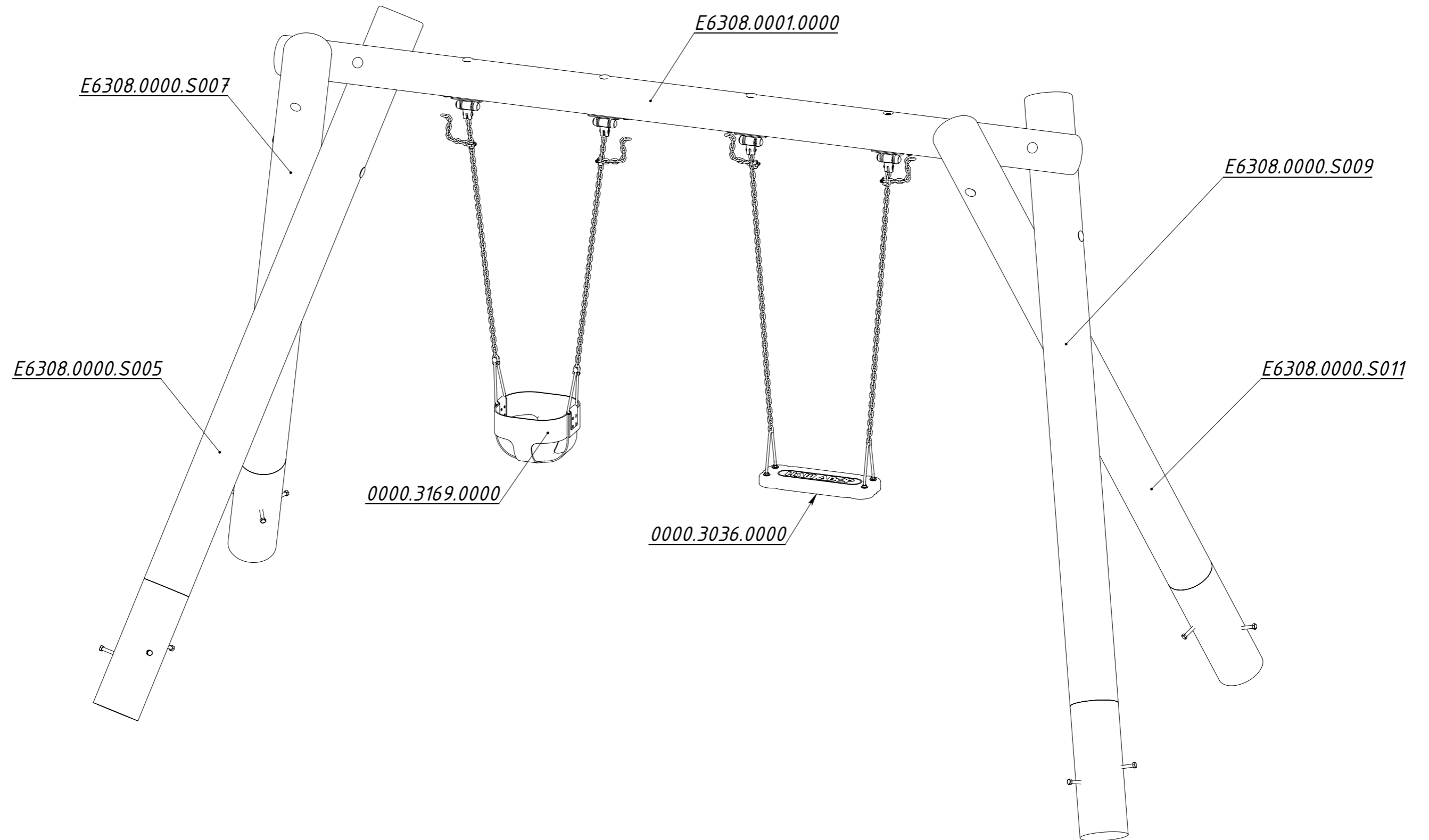
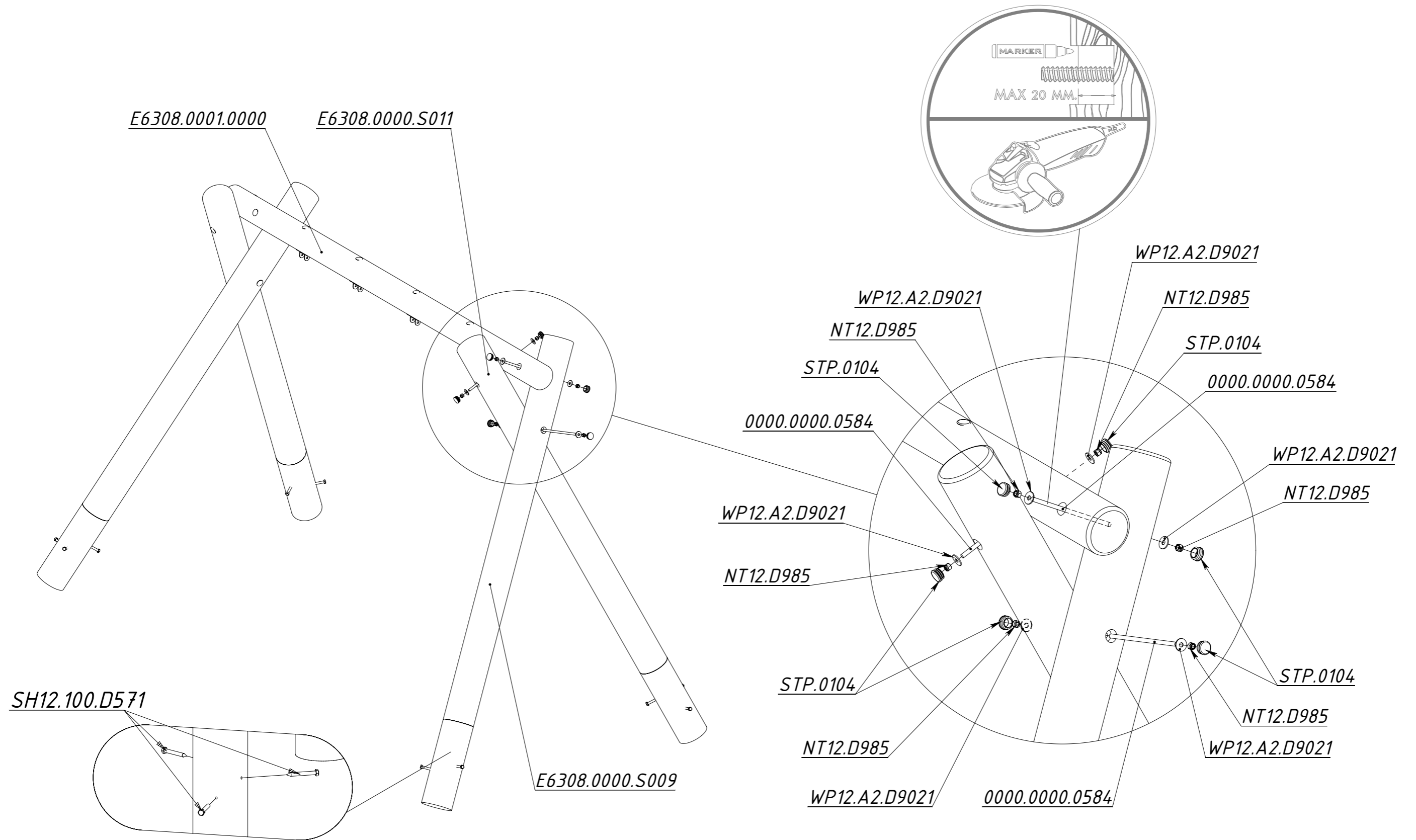
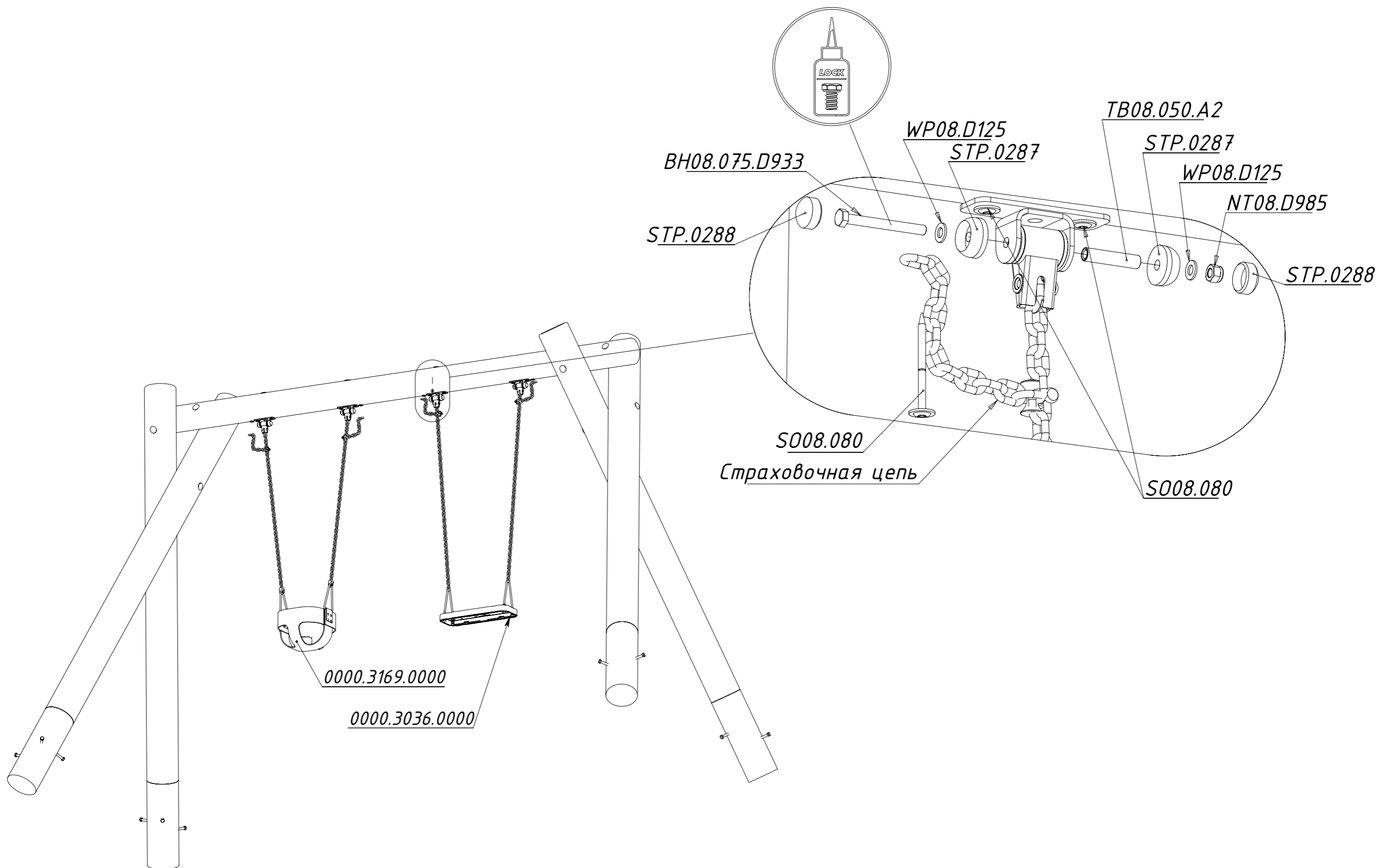

Рисунок 3