

**Схема скважин
4018.0000.0000**

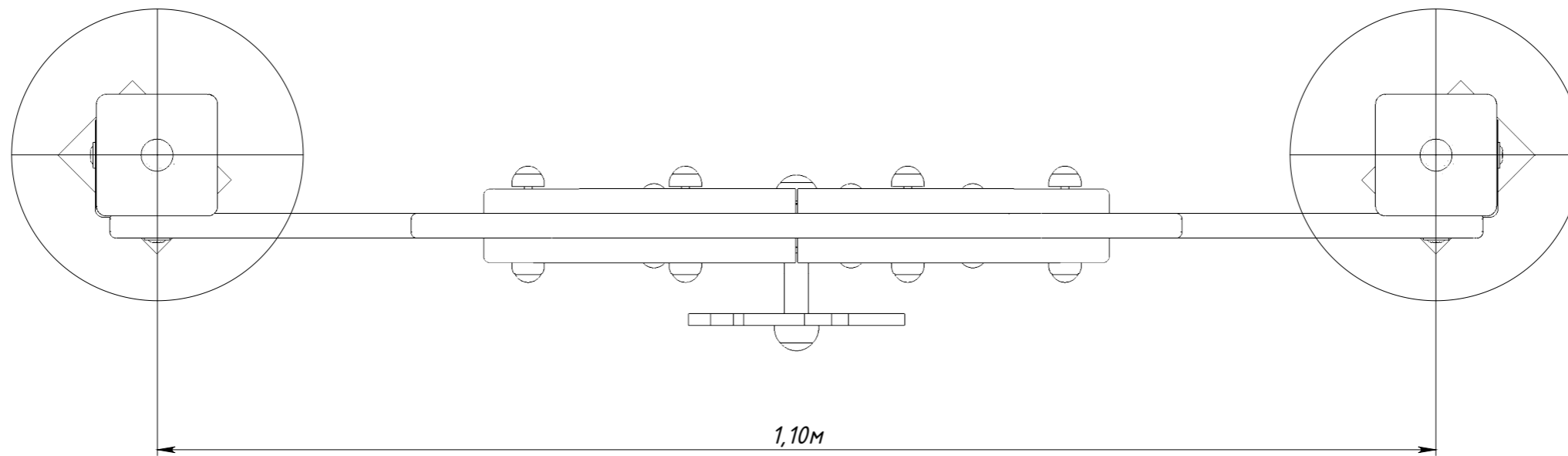

Рисунок 1