

Схема скважин
4016.0000.0000

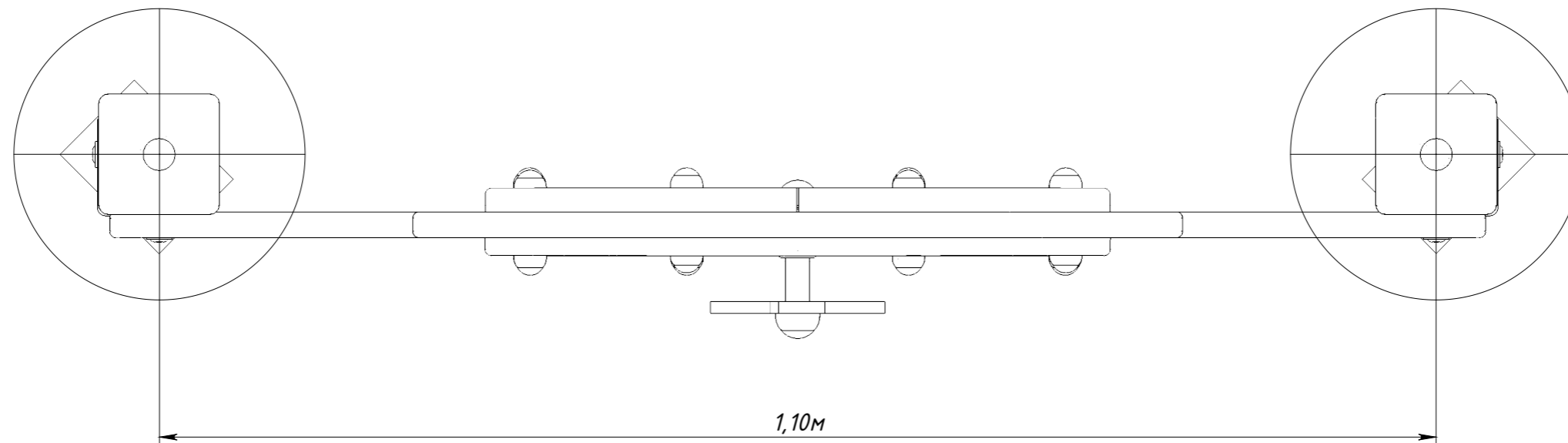

Рисунок 1