

Схема скважин
E2104.0000.0000

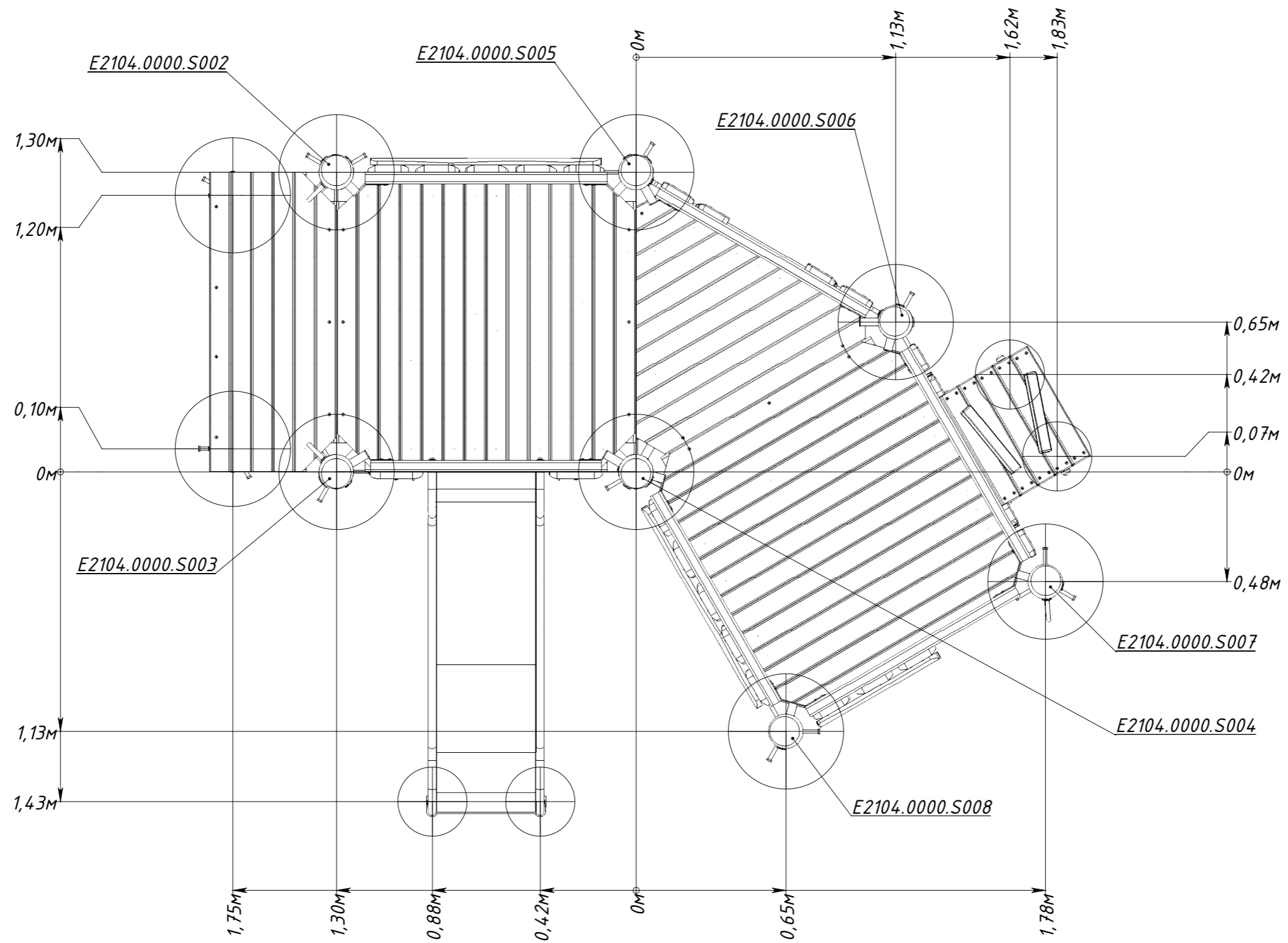

Рисунок 1