

Схема скважин
E5502.0000.0000

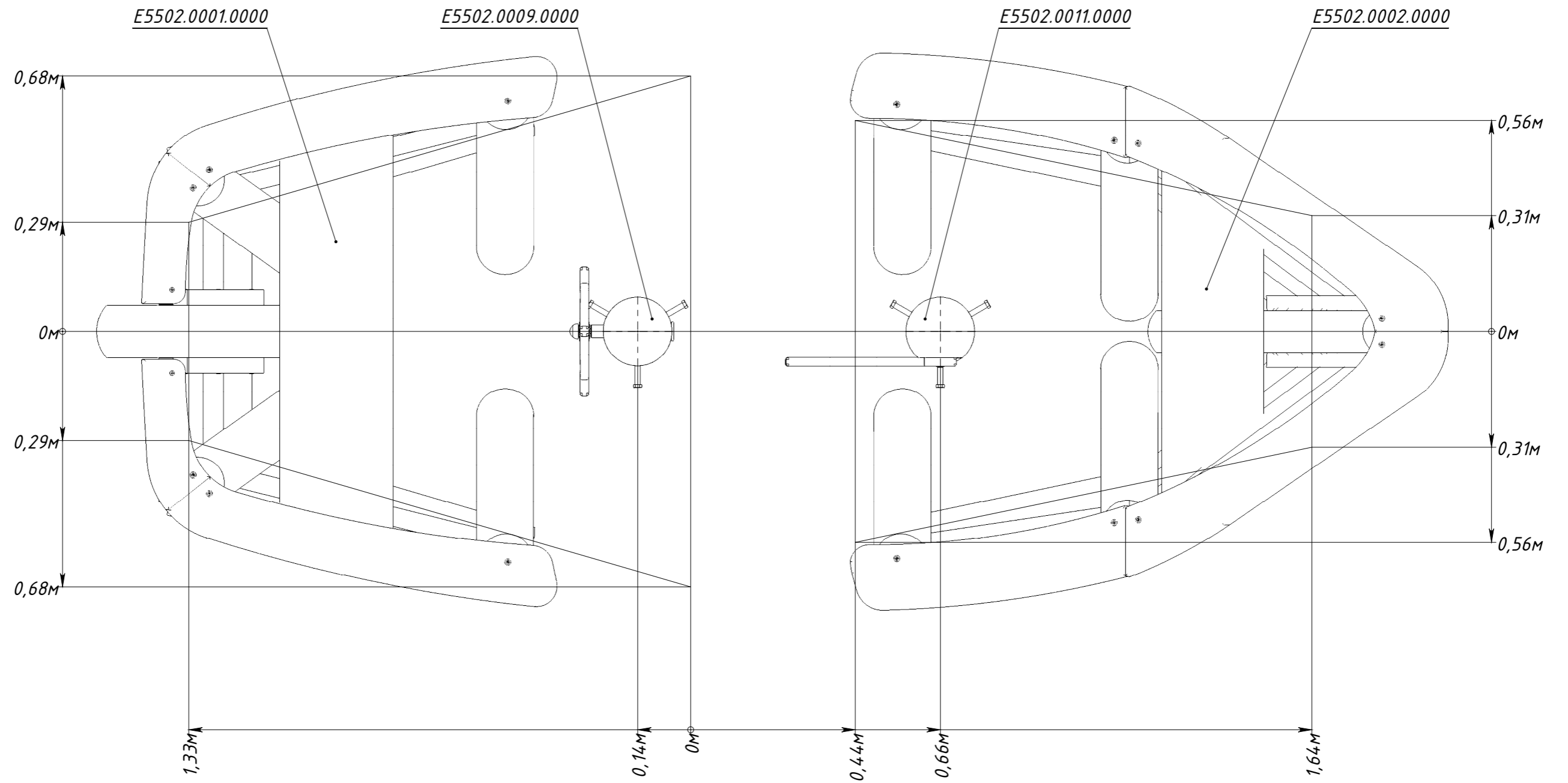

Рисунок 1