

Схема скважин
8033.0000.0000

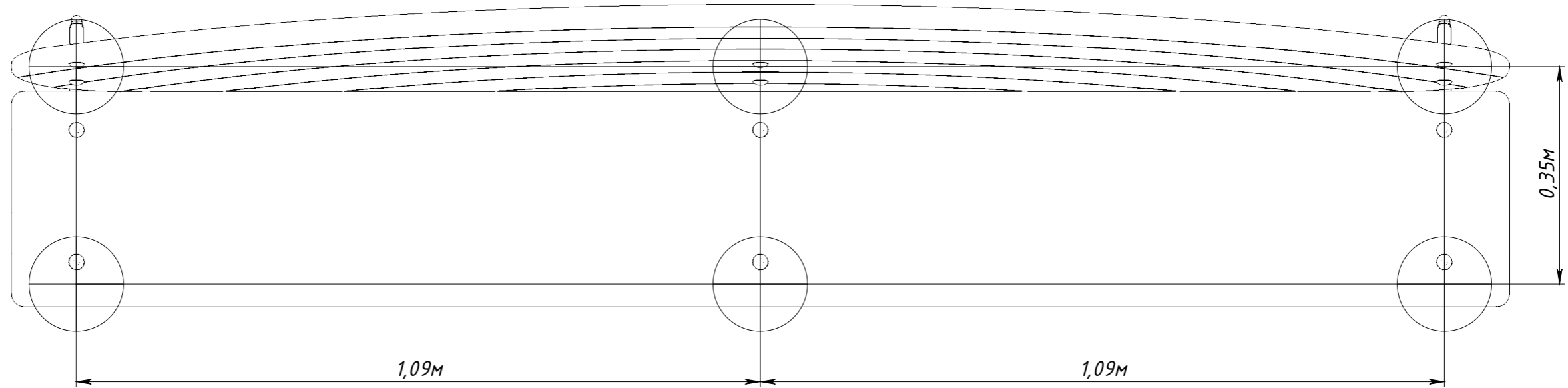

Рисунок 1