

Схема скважин  
8015.0000.0000

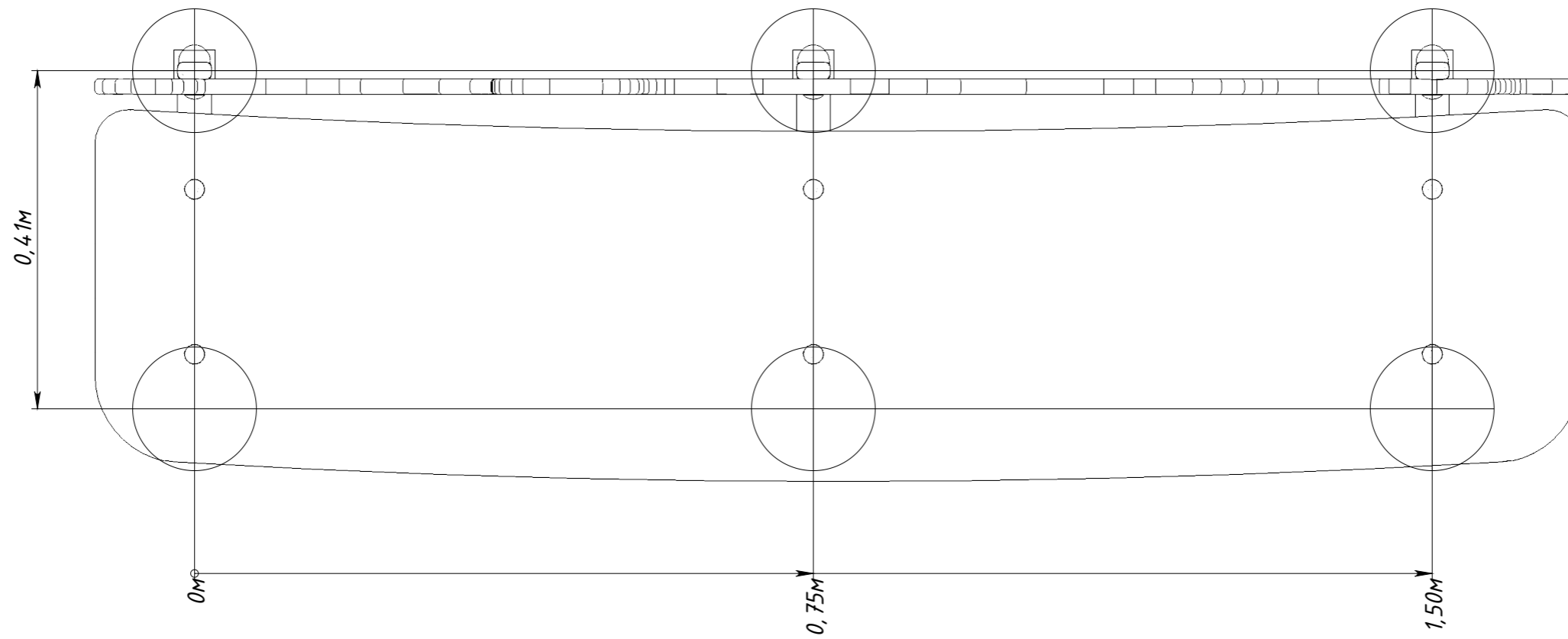

Рисунок 1