

Схема скважин
7804.0000.0000

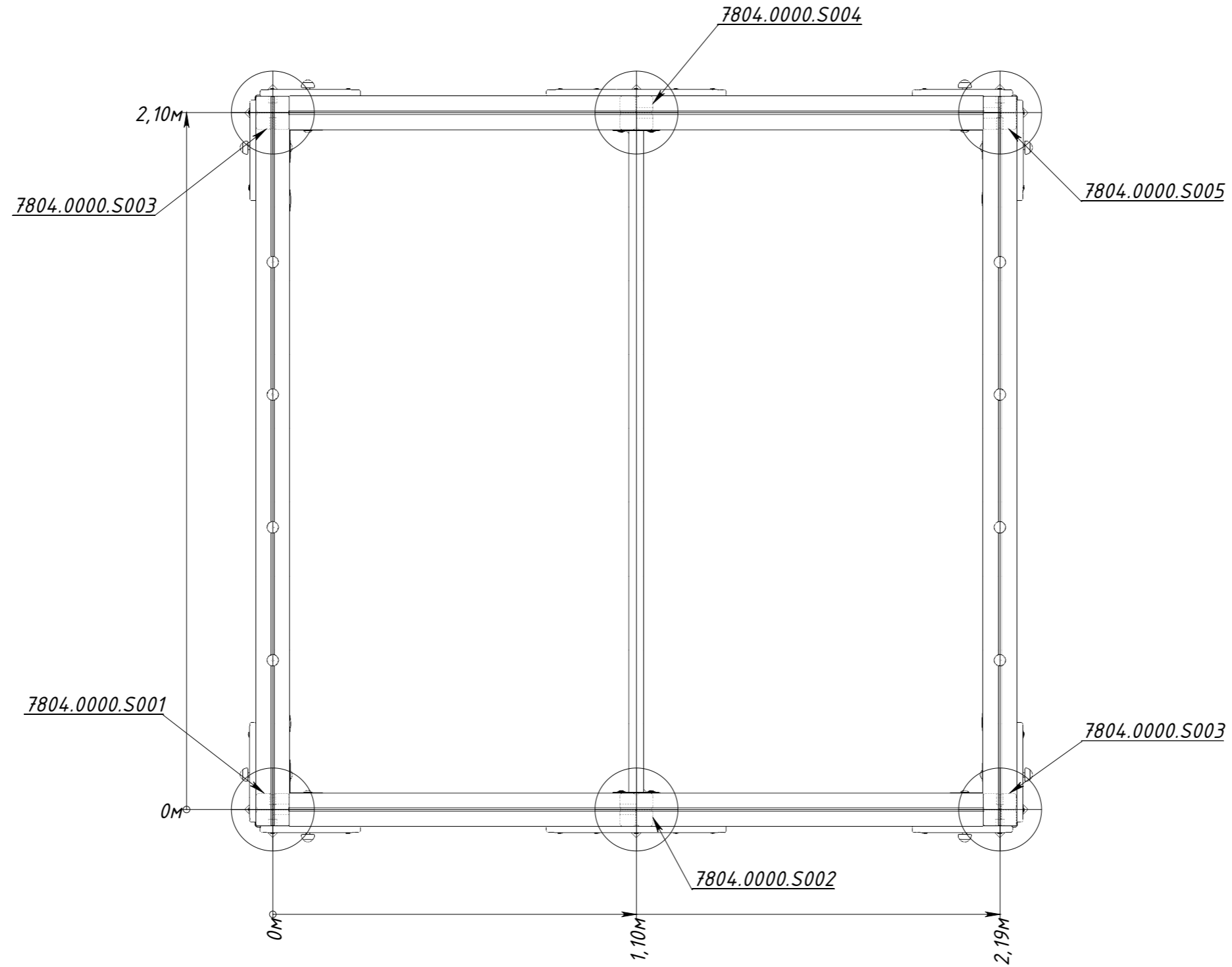

Рисунок 1