

Схема скважин  
6329.0000.0000

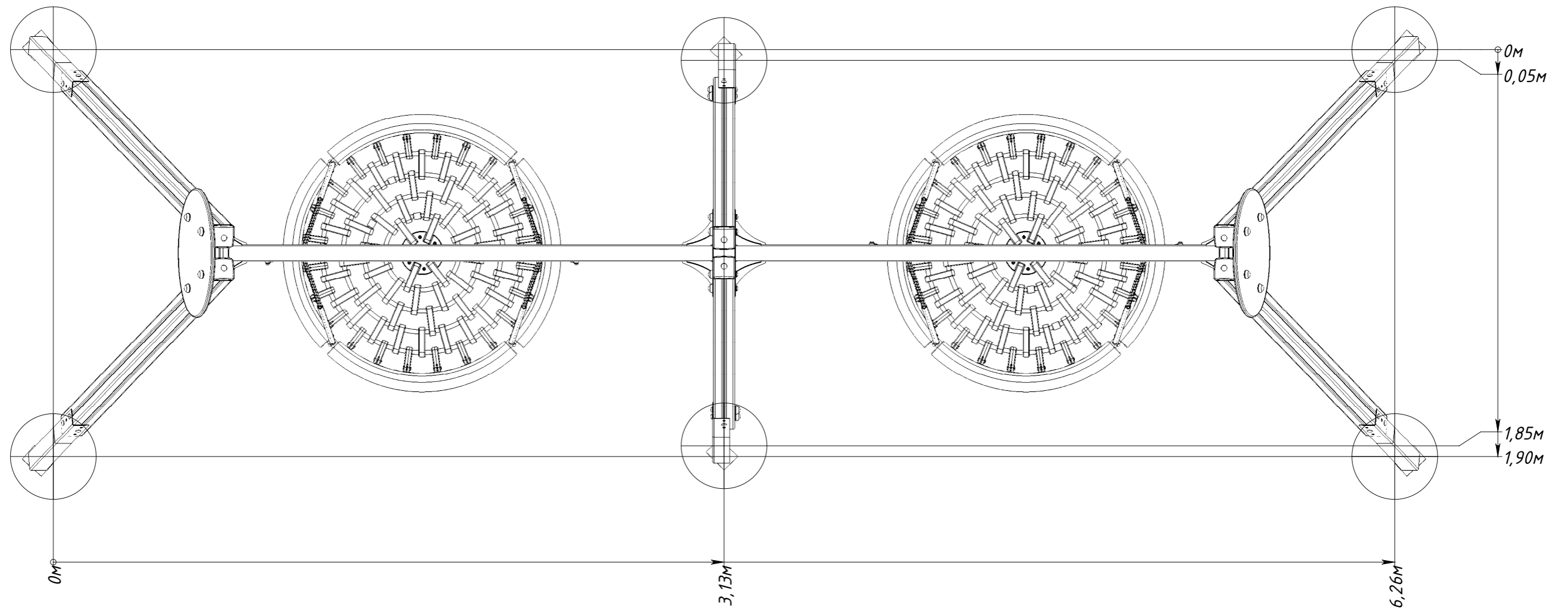

Рисунок 1