

Схема скважин
6201.0000.0000

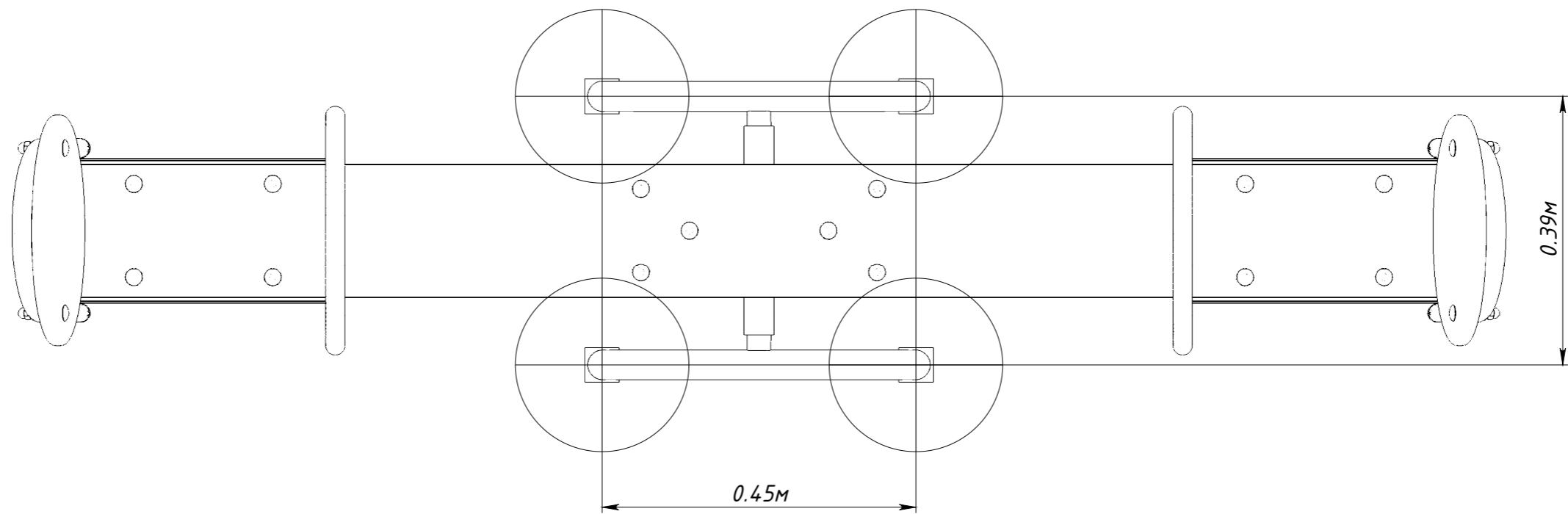

Рисунок 1