

Схема скважин
E6305.0000.0000

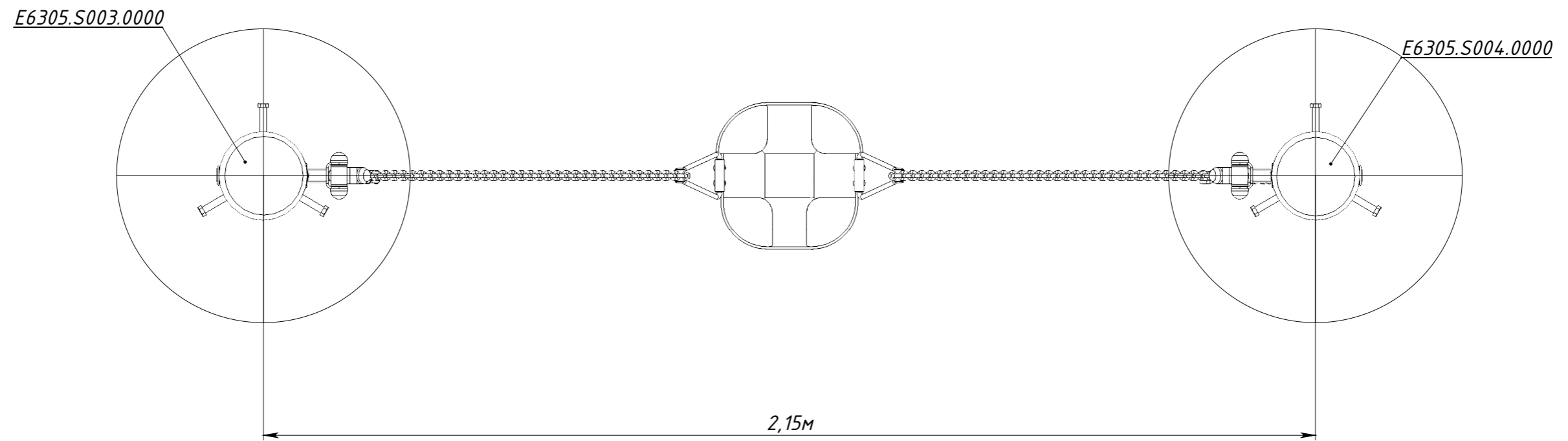

Рисунок 1